

# Guide cylinders, Series SH

SH03103LB16DS4

Series SH

2024-06-17

- Stainless steel cylinder body and rods for corrosion resistance
- Alignment coupler with 360 degrees of float eliminates cylinder side loading
- Hardened steel guide shafts with large diameters for increased load capability
- Precision bearings sealed with rod wipers are maintenance free and provide self-alignment, self-lubrication, and low friction
- Clamp position of sensor

## AVENTICS Series SH

The AVENTICS Series SH guided linear slide is a motion device capable of heavy loads and moderately long strokes. It is interchangeable with competitive heavy-duty slides. The SH Series is suitable for analytical and diagnostic instrument, automotive, bottling, and commercial kitchen and laundry equipment applications.



## Technical data

Industry	Industrial
Piston Ø	5/16"
Stroke	3"
Bearing type	Linear ball bearing
Mounting type	Standard mounting
Magnetic piston	Piston without magnet
Position inquiry	w/o position inquiry
Switch descr.	w/o position inquiry
Cushioning	no cushioning
Min. ambient temperature	-10 °F
Max. ambient temperature	165 °F
Retracting piston force	0.06 lbf
Extracting piston force	0.07 lbf
Weight 0 inch stroke	0.35 lbs
Weight 1 inch stroke	0.03 lbs

## Material

Housing material	Hardcoat Anodized Aluminum
Seal material	Buna-N

# Guide cylinders, Series SH

SH03103LB16DS4

Series SH

2024-06-17

---

Material front plate	Hardcoat Anodized Aluminum
Material guide rods	Sintered steel
Material piston rod	Sintered steel
Part No.	SH03103LB16DS4

## Technical information

The pressure dew point must be at least 15 °C less than ambient and medium temperature and may not exceed 3 °C.

The oil content of compressed air must remain constant during the life cycle.

Use only the approved oils from AVENTICS. Further information can be found in the “Technical information” document (available in <https://www.emerson.com/en-us/support>).

# Guide cylinders, Series SH

SH03103LB16DS4

Series SH

2024-06-17

## Dimensions in inches

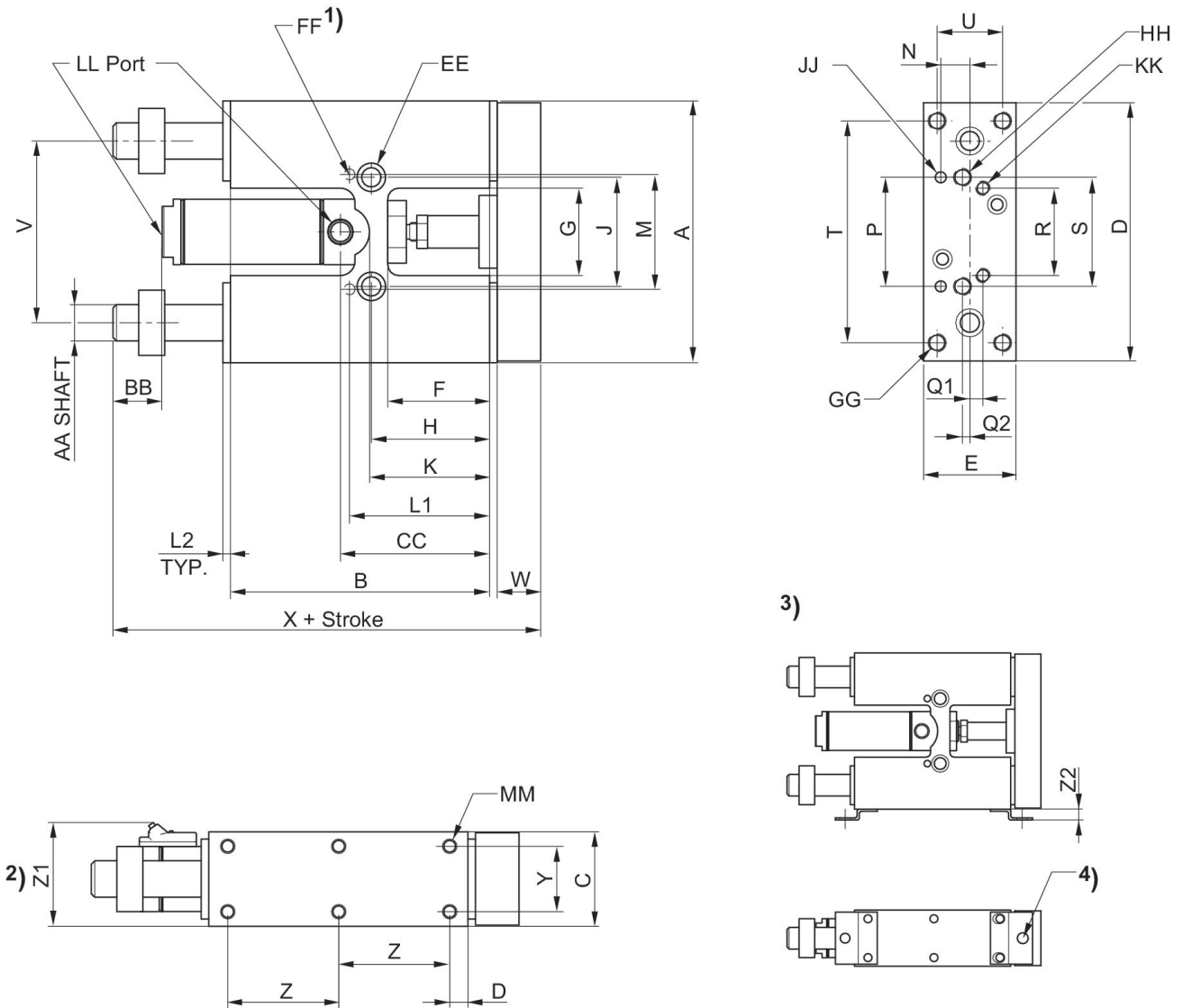

- 1) is located on the bottom
- 2) Optional Hall effect and reed sensors
- 3) Retaining bracket for proximity sensor
- 4) Hole for proximity sensor, M8

Ø [inch]	A	B	C	D	E	F	G	H	J
5/16"	2.00	2.00	0.62	1.95	0.58	0.75	0.75	0.90	1.00
9/16"	2.87	3.00	1.00	2.81	0.95	1.00	1.00	1.25	1.25
3/4"	4.12	3.97	1.25	4.06	1.19	1.31	1.25	1.59	1.50
1 1/16"	4.50	4.45	1.62	4.44	1.58	1.75	1.50	2.03	1.87

Ø [inch]	K	L1	L2	M	N	P	Q1	Q2	R
5/16"	1.06	1.12	0.06	0.999/1.001	0.21	0.999/1.001	-	Center Line	-
9/16"	1.50	1.56	0.12	1.373/1.375	0.31	1.373/1.375	0.18	Center Line	1.00
3/4"	1.66	1.96	0.12	1.881/1.813	0.37	1.881/1.813	0.31	Center Line	1.25

# Guide cylinders, Series SH

SH03103LB16DS4

Series SH

2024-06-17

Ø [inch]	K	L1	L2	M	N	P	Q1	Q2	R
1 1/16"	2.31	2.40	0.12	1.873/1.875	0.50	1.873/1.875	0.22	0.12	1.50

Ø [inch]	S	T	U	V	W	X	Y	Z	Z1
5/16"	1.00	-	-	1.56	0.31	3.06	0.43	0.50	-
9/16"	1.25	2.37	0.62	2.00	0.50	4.44	0.62	1.18	1.32
3/4"	1.50	3.37	0.81	2.75	0.62	5.68	0.81	1.68	1.53
1 1/16"	1.87	3.81	1.12	3.12	0.75	6.31	1.12	1.90	1.88

Ø [inch]	Z2	AA	BB	CC	DD	EE	FF	GG	HH
5/16"	-	0.250	0.31	1.06	0.50	C'Bored for #6 SHCS, Tapped # 10-32 x .28 DP	0.0937/0.0947 x 0.18DP	-	#6-32 thru
9/16"	0.31	0.375	0.50	1.68	0.31	C'Bored for #10 SHCS, Tapped 1/4-28 x .50 DP	0.125/0.126 x 0.25DP	#10-32 thru, C'Bored for #6 SHCS	#10-32 thru, C'Bored for #6 SHCS
3/4"	0.31	0.500	0.62	2.03	0.31	C'Bored for 1/4 SHCS, Tapped 5/16-24 x .62 DP	0.1875/0.1885 x .37DP	1/4-20 thru, C'Bored for #10 SHCS	1/4-20 thru, C'Bored for #10 SHCS
1 1/16"	0.31	0.625	0.81	2.50	0.31	C'Bored for 5/16 SHCS, Tapped 3/8-24 x .75 DP	0.1875/0.1885 x .37DP	5/16-18 thru, C'Bored for 1/4 SHCS	5/16-18 thru, C'Bored for 1/4 SHCS

Ø [inch]	JJ	KK	LL	MM
5/16"	0.0937/0.0947 x 0.18DP	-	#10-32	#5-40 x .18 DP
9/16"	0.125/0.126 x 0.25DP	#6-32 x .25DP	#10-32	#6-32 x .20 DP
3/4"	0.1875/0.1885 x .37DP	#10-32 x .37DP	1/8 NPTF	#10-32 x .28 DP
1 1/16"	0.1875/0.1885 x .37DP	1/4-20 x .50DP	1/8 NPTF	1/4-20 x .37 DP