

- Available in piston diameters from 32 mm to 125 mm
- Advanced pneumatic cushioning
- Additional elastic damping elements
- Wide range of scraper modules available
- With the modular system you can change the scraper on the cylinder at any time and considerably decrease service intervals
- Wide range of variants and accessories available in the configurator

AVENTICS Series TRB Tie rod cylinders (ISO 15552)

The AVENTICS Series TRB (ISO 15552) cylinders are among the most frequently implemented in industries where heavy duty cylinders are required, such as wood and aluminium, steel and automotive, heavy-duty machinery and mining to name just a few.



Technical data

Industry	Industrial
Standards	ISO 15552
Piston Ø	32 mm
Stroke	125 mm
Ports	G 1/8
Functional principle	Double-acting
Cushioning	Pneumatic adjustable cushioning
Magnetic piston	With magnet
Environmental requirements	cold-resistant Industry standard
Piston rod thread - type	External thread
Piston rod thread	M10x1,25
Piston rod	single
Scraper	Cold-Resistant Scraper
Pressure for determining piston forces	6,3 bar
Retracting piston force	435 N
Extracting piston force	505 N
Min. ambient temperature	-40 °C
Max. ambient temperature	70 °C
Min. working pressure	1.5 bar

Tie rod cylinder ISO 15552, Series TRB

series TRB

R480691902

2025-09-03

Max. working pressure	10 bar
Cushioning length	11.5 mm
Cushioning energy	4.8 J
Weight 0 mm stroke	0.46 kg
Weight +10 mm stroke	0.024 kg
Stroke max.	1600 mm
Medium	Compressed air
Min. medium temperature	-40 °C
Max. medium temperature	70 °C
Max. particle size	50 µm
Min. oil content of compressed air	0 mg/m ³
Max. oil content of compressed air	5 mg/m ³

Material

Piston rod	Stainless Steel
Scraper material	Brass
Material tie-rod	Stainless Steel
Seal material	Polyurethane
Material, front cover	Die-cast aluminum
Cylinder tube	Aluminum
End cover	Die-cast aluminum
Nut for piston rod	Steel, chrome-plated
Part No.	R480691902

Technical information

The pressure dew point must be at least 15 °C less than ambient and medium temperature and may not exceed 3 °C.

The oil content of compressed air must remain constant during the life cycle.

Use only the approved oils from AVENTICS. Further information can be found in the “Technical information” document (available in <https://www.emerson.com/en-us/support>).

Tie rod cylinder ISO 1552, Series TRB

series TRB

R480691902

2025-09-03

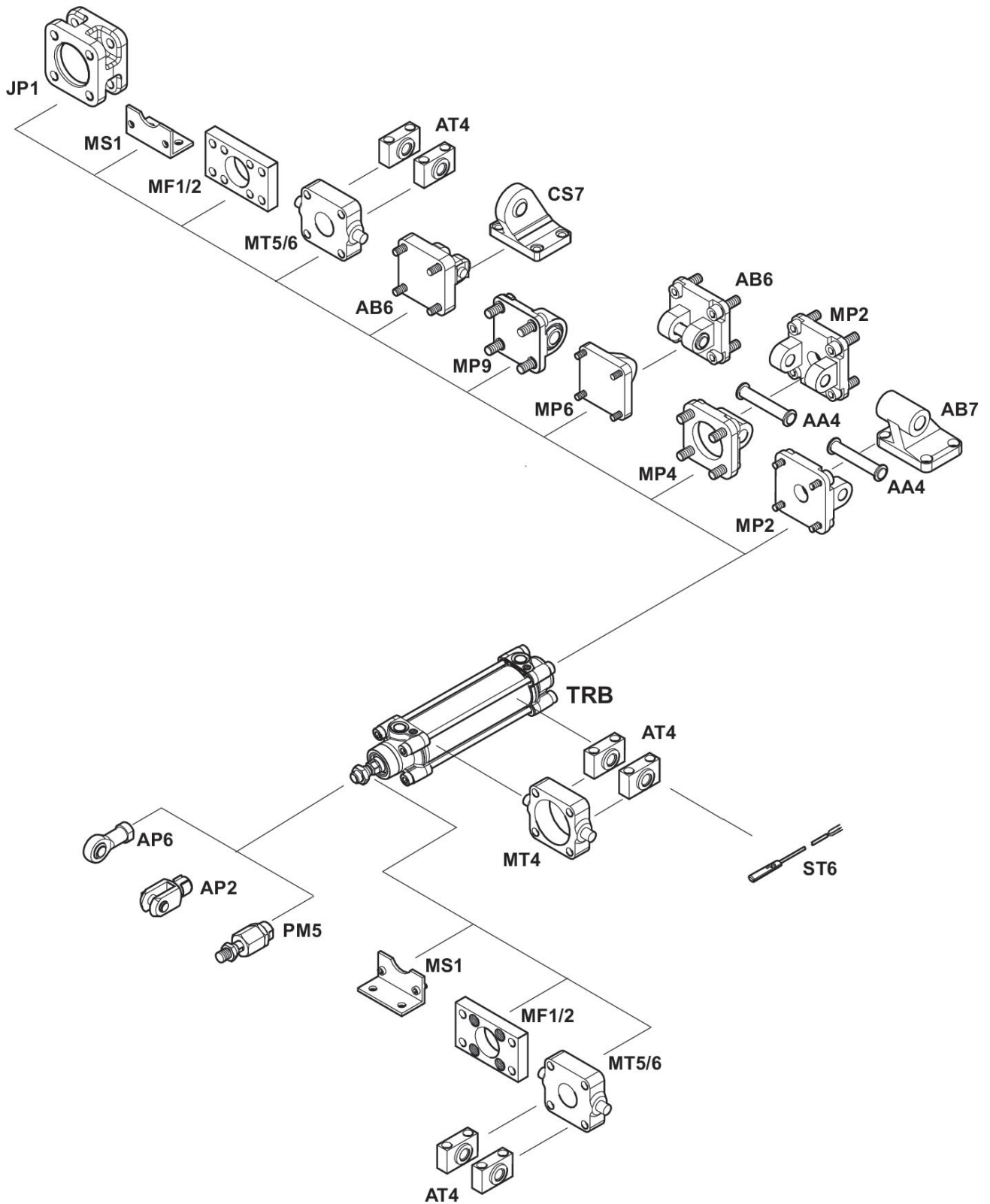

Tie rod cylinder ISO 15552, Series TRB

R480691902

series TRB

2025-09-03

Cushioning diagram



v_t = Piston velocity [m/s] m = Cushionable mass [kg]

Dimensions



S = stroke

*) For cylinders with optional piston rod with internal thread

Tie rod cylinder ISO 15552, Series TRB

R480691902

series TRB

2025-09-03

Piston Ø	A -2	AF+1	ØB d11	ØBA d11	BG min.	E	EE	G	H	KF
32	22	12	30	30	16	46.5	G 1/8	27.75	47.5	M6
40	24	13.5	35	35	16	53	G 1/4	33.25	53	M8
50	32	17	40	40	16	65	G 1/4	31	65	M10
63	32	17	45	45	16	75	G 3/8	38.25	75	M10
80	40	21	45	45	17	95	G 3/8	38.25	95	M12
100	40	21	55	55	17	115	G 1/2	42.25	115	M12
125	54	28	60	60	20	140	G 1/2	53.85	140	M16

Piston Ø	KK	KV	KW	ØMM f8	PL	L2	L3 ±0,5	L8	RT	SW
32	M10x1,25	16	5	12	16	16.25	4.5	94±0,4	M6	10
40	M12x1,25	18	6	16	20	18.25	4.5	105±0,7	M6	13
50	M16x1,5	24	8	20	19	25	4.5	106±0,7	M8	17
63	M16x1,5	24	8	20	24	25	4.5	121±0,8	M8	17
80	M20x1,5	30	10	25	23.5	33	0	128±0,8	M10	22
100	M20x1,5	30	10	25	25	36	0	138±1	M10	22
125	M27x2	41	13.5	32	33	45	0	160±1	M12	27

Piston Ø	TG	VA -1	VD	WH
32	32,5±0,5	4	5	26±1,4
40	38±0,5	4	5	30±1,4
50	46,5±0,6	4	5	37±1,4
63	56,5±0,7	4	5	37±1,8
80	72±0,7	4	5	46±1,8
100	89±0,7	4	5	51±1,8
125	110±1,1	6	7	65±2,2