

AVENTICS Series CCL-IC Standard cylinders (ISO 21287)

The AVENTICS Series CCL-IC (ISO 21287) cylinders with their compact and clean design can be used in a wide range of applications. Their smooth surface together with their materials, such as anodized aluminium, stainless steel, and NSF-H1 lubricants, make the cylinder ideal for the demanding requirements in the food and beverage industry.

- Compact clean design
- Available in nine sizes covering piston diameters from 16 mm to 100 mm
- Easy to clean anodized surfaces
- Scrapers and lubricants (NSF-H1) are approved for food applications
- Hygienic protective caps for unused mounting holes
- Universal mounting concept for easy assembly, without the need for additional mounting elements



Technical data

Industry	Industrial
Standards	ISO 21287
Piston Ø	100 mm
Stroke	100 mm
Ports	G 1/8
Functional principle	Double-acting
Cushioning	elastic cushioning
Magnetic piston	Piston with magnet
Environmental requirements	Industry standard suitable for use in food processing ATEX optional High corrosion
Piston rod thread - type	External thread
Piston rod thread	M16x1,5
Piston rod	single
Scraper	Standard Industry Scraper
Pressure for determining piston forces	6,3 bar
Retracting piston force	4639 N
Extracting piston force	4948 N
Min. ambient temperature	-20 °C

Compact cylinder ISO 21287, Series CCL-IC

R480668784

Series CCL-
IC

2026-01-20

Max. ambient temperature	80 °C
Min. working pressure	1 bar
Max. working pressure	10 bar
Impact energy	2.5 J
Weight 0 mm stroke	2.33 kg
Weight +10 mm stroke	0.108 kg
Stroke max.	500 mm
Medium	Compressed air
Min. medium temperature	-20 °C
Max. medium temperature	80 °C
Max. particle size	50 µm
Min. oil content of compressed air	0 mg/m ³
Max. oil content of compressed air	5 mg/m ³

Material

Piston rod	Stainless Steel
Scraper material	Polyurethane
Material, front cover	Aluminum
Cylinder tube	Aluminum
End cover	Aluminum
Part No.	R480668784

Technical information

The material for heat-resistant scraper and seal variants (ambient temperature: -10 °C ... 120 °C) is fluorocarbon.

Further options can be generated in the Internet configurator.

LW*/SW* Hexagonal key required

The pressure dew point must be at least 15 °C less than ambient and medium temperature and may not exceed 3 °C.

The oil content of compressed air must remain constant during the life cycle.

ATEX-certified cylinders with identification II 2G Ex h IIC T4 Gb / II 2D Ex h IIIC T135°C Db_X can be generated in the Internet configurator.

Compact cylinder ISO 21287, Series CCL-IC

Series CCL-
IC

R480668784

2026-01-20

Dimensions

Ø16 - 63

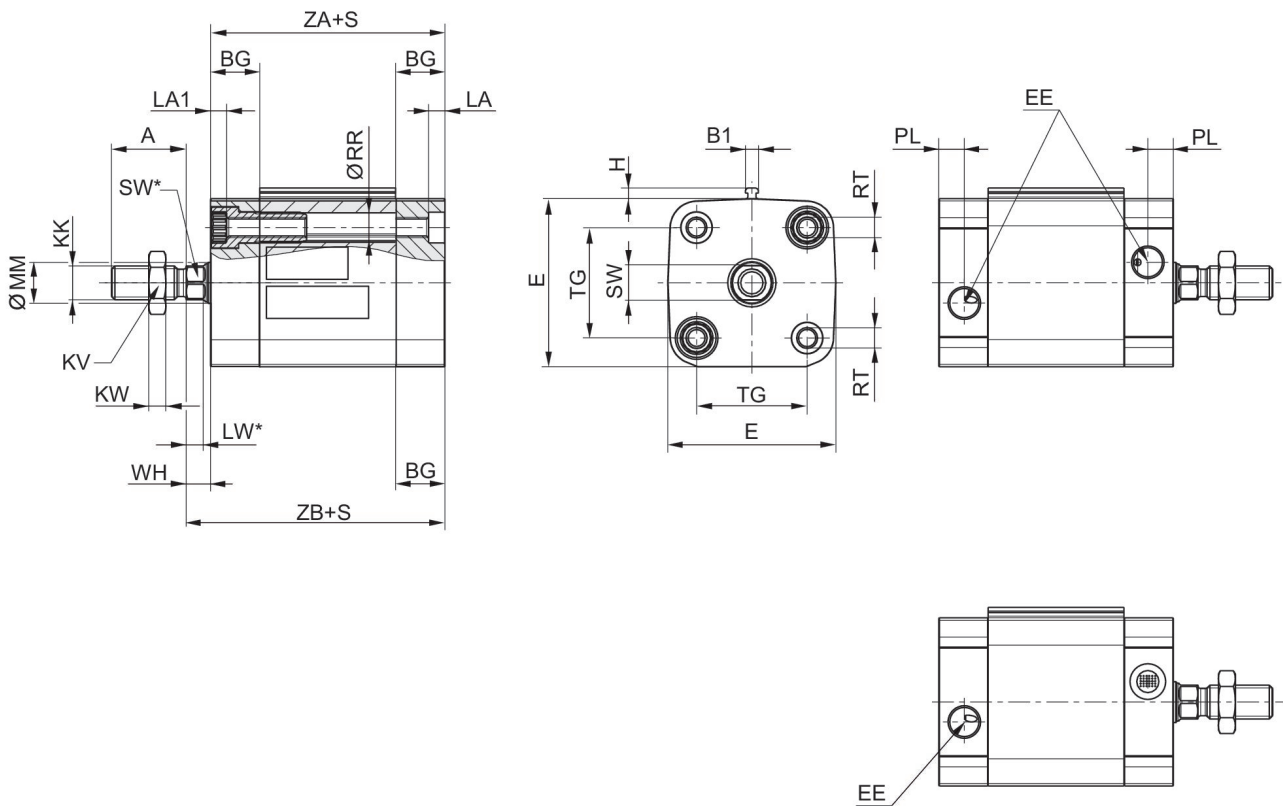

Ø80 - 100

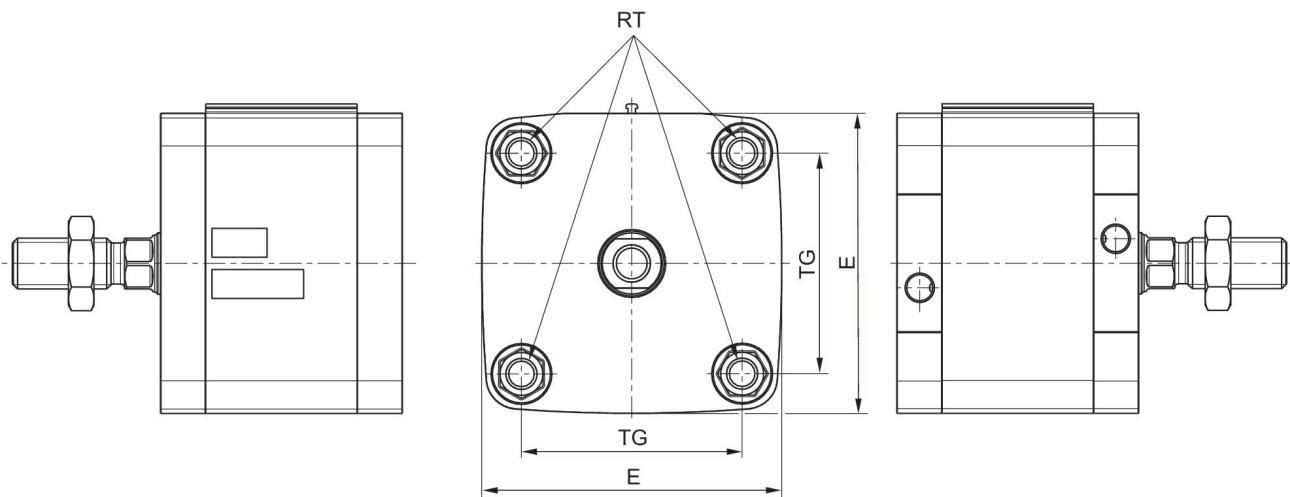

S = stroke

Compact cylinder ISO 21287, Series CCL-IC

R480668784

Series CCL-
IC

2026-01-20

Piston Ø	A	B1	BG min.	E	EE	H	KK	KV	KW	LA
16	12	3.8	15	29	M5	3.1	M6	10	3.2	3.5
20	16	3.8	15	36.5	M5	3.1	M8	13	4	4.8
25	16	3.8	15	40.5	M5	3.1	M8	13	4	4.8
32	19	3.8	16	49.5	G1/8	3.1	M10x1.25	17	5	4.8
40	19	3.8	16	57.5	G1/8	3.1	M10x1.25	17	5	4.8
50	22	3.8	16	69.5	G1/8	3.1	M12x1.25	18	6	4.8
63	22	3.8	16	79.5	G1/8	3.1	M12x1.25	18	6	4.8
80	28	3.8	17	98 / ISO 21287:96	G1/8	3.1	M16x1.5	24	8	0
100	28	3.8	17	115.5	G1/8	3.1	M16x1.5	24	8	0

Piston Ø	LA1	LW	LW*	MM f8	PL	RR min.	RT	SW	SW*	TG
16	3.5	3.2	3.2	8	5	3.2	M4	7	7	18 ±0,4
20	4.6	3.7	3.7	10	5	4.1	M5	8	8	22 ±0,4
25	4.6	3.7	3.7	10	5	4.1	M5	8	8	26 ±0,4
32	4.8	5	5*	12	7.5	5.1	M6	10	10*	32,5 ±0,5
40	4.8	5	5*	12	7.5	5.1	M6	10	10*	38 ±0,5
50	4.8	5.7	4,8*	16	7.5	6.4	M8	13	13*	46,5 ±0,6
63	4.8	5.7	4,8*	16	7.5	6.4	M8	13	13*	56,5 ±0,7
80	0	7	6,4*	20	7.5	8.4	M10	16	16*	72 ±0,7
100	0	7.5	6,4*	25	7.5	8.4	M10	21	21*	89 ±0,7

Piston Ø	WH	ZA +S	ZB+S
16	4,8 ±1,4	36	40.8
20	6 ±1,4	37	43
25	6 ±1,4	39	45
32	7 ±1,6	44	51
40	7 ±1,6	45	52
50	8 ±1,6	45.5	53.5
63	8 ±1,6	49	57
80	10 ±2	54	64
100	10 ±2	67	77

Compact cylinder ISO 21287, Series CCL-IC

R480668784

Series CCL-
IC

2026-01-20

Overview drawing



NOTE: This overview drawing is only for orientation to indicate where the various accessory parts can be fastened to the cylinder. The illustration has been simplified for this purpose. It is thus not possible to derive the dimensions from this overview.

Compact cylinder ISO 21287, Series CCL-IC

R480668784

Series CCL-
IC

2026-01-20

Dimensions

Ø80 - 100

