

- 6 mm T-slots and 4 mm C-slots allow for a large number of sensors to be mounted easily, quickly and compactly
- Available in piston diameters from 32 mm to 125 mm
- Modular sealing system allows for adaptability
- Advanced pneumatic end position cushioning
- Additional elastic damping elements
- Wide range of variants and accessories available in the configurator

## AVENTICS Series PRA Profile cylinders (ISO 15552)

The AVENTICS Series PRA (ISO 15552) cylinders have a compact design profile with integrated sensor slots. The Series PRA (ISO 15552) cylinders can be used for all industries. This includes general automation technology, machine and systems construction, as well as specific industry applications.



## Technical data

Industry	Industrial
Standards	ISO 15552
Piston Ø	50 mm
Stroke	50 mm
Ports	G 1/4
Functional principle	Double-acting
Cushioning	Pneumatic adjustable cushioning
Magnetic piston	Piston with magnet
Environmental requirements	Industry standard ATEX optional
Piston rod thread - type	External thread
Piston rod thread	M16x1,5
Piston rod	through
Scraper	Standard Industry Scraper
Pressure for determining piston forces	6,3 bar
Retracting piston force	1035 N
Extracting piston force	1035 N
Min. ambient temperature	-20 °C
Max. ambient temperature	80 °C
Min. working pressure	1.5 bar

# Profile cylinder ISO 15552, PRA series

R480041444

series PRA

2025-08-20

Max. working pressure	10 bar
Cushioning length	17 mm
Cushioning energy	15 J
Weight 0 mm stroke	1.34 kg
Weight +10 mm stroke	0.072 kg
Stroke max.	1500 mm
Medium	Compressed air
Min. medium temperature	-20 °C
Max. medium temperature	80 °C
Max. particle size	50 µm
Min. oil content of compressed air	0 mg/m <sup>3</sup>
Max. oil content of compressed air	5 mg/m <sup>3</sup>

## Material

Piston rod	Stainless Steel
Scraper material	Polyurethane
Seal material	Polyurethane
Material, front cover	Die-cast aluminum
Cylinder tube	Aluminum
End cover	Die-cast aluminum
Nut for piston rod	Steel, chrome-plated
Part No.	R480041444

## Technical information

The pressure dew point must be at least 15 °C less than ambient and medium temperature and may not exceed 3 °C.

The oil content of compressed air must remain constant during the life cycle.

Use only the approved oils from AVENTICS. Further information can be found in the "Technical information" document (available in <https://www.emerson.com/en-us/support>).

# Profile cylinder ISO 1552, PRA series

R480041444

series PRA

2025-08-20



# Profile cylinder ISO 1552, PRA series

R480041444

series PRA

2025-08-20

## Cushioning diagram



$v_t$  = Piston velocity [m/s]  $m$  = Cushionable mass [kg]

## Dimensions

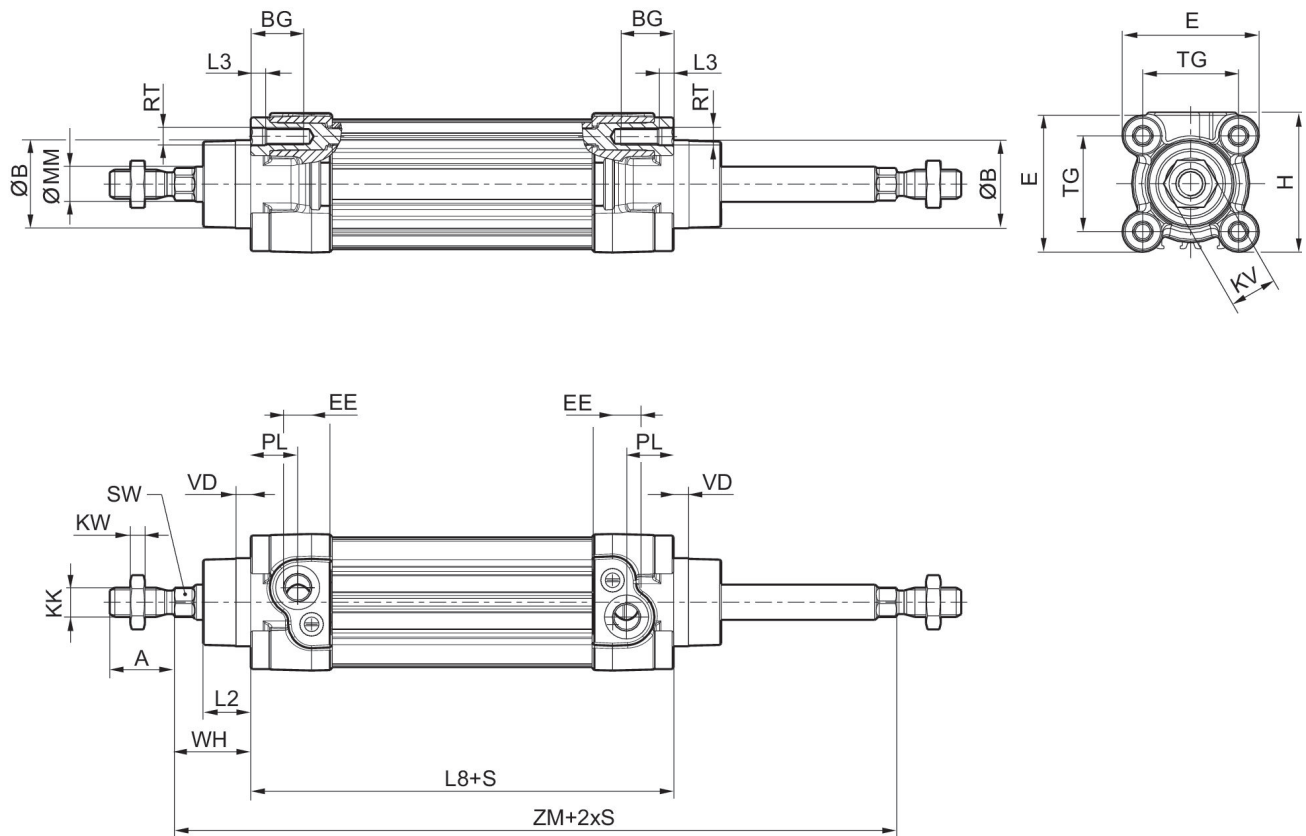

S = stroke

# Profile cylinder ISO 15552, PRA series

R480041444

series PRA

2025-08-20

Piston Ø	A -2	ØB d11	BG min.	E	EE	G	H	KK	KV	KW
32	22	30	16	46.5	G 1/8	27.75	47.5	M10x1,25	16	5
40	24	35	16	53	G 1/4	33.25	53	M12x1,25	18	6
50	32	40	16	65	G 1/4	31	65	M16x1,5	24	8
63	32	45	16	75	G 3/8	38.25	75	M16x1,5	24	8
80	40	45	17	95	G 3/8	38.25	95	M20x1,5	30	10
100	40	55	17	115	G 1/2	42.25	115	M20x1,5	30	10
125	54	60	20	140	G 1/2	53.85	140	M27x2	41	13.5

Piston Ø	ØMM f8	PL	L2	L3 ±0,5	L8	RT	SW	TG	VD	WH
32	12	16	16.25	4.5	94±0,4	M6	10	32,5±0,5	5	26±1,4
40	16	20	18.25	4.5	105±0,7	M6	13	38±0,5	5	30±1,4
50	20	19	25	4.5	106±0,7	M8	17	46,5±0,6	5	37±1,4
63	20	24	25	4.5	121±0,8	M8	17	56,5±0,7	5	37±1,8
80	25	23.5	33	0	128±0,8	M10	22	72±0,7	5	46±1,8
100	25	25	36	0	138±1	M10	22	89±0,7	5	51±1,8
125	32	33	45	0	160±1	M12	27	110±1,1	7	65±2,2

Piston Ø	ZM
32	146+3/-1,5
40	165+3/-1,5
50	180+3/-1,5
63	195+3/-1,5
80	220+3/-1,5
100	240+3,5/-2
125	290+3,5/-2