

- Compact narrow design
- Precise load capacity
- Unlimited mounting options

AVENTICS Series MSN Guide cylinders

The AVENTICS Series MSN mini slides offer precise guidance without play in a very narrow package. With their wide variety of mounting and air supply options the Series allows for applications in virtually any position and location.

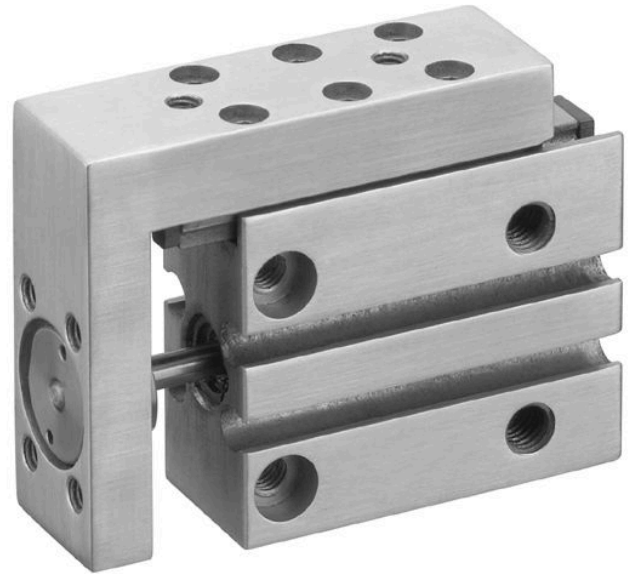

Technical data

Industry	Industrial
Note	narrow version
Piston Ø	6 mm
Stroke	5 mm
Functional principle	Double-acting
Port	M5
Cushioning	elastic
Min. working pressure	2.5 bar
Max. working pressure	10 bar
Min. ambient temperature	0 °C
Max. ambient temperature	60 °C
Medium	Compressed air
Retracting piston force, theoretical	13 N
Extracting piston force, theoretical	18 N
Max. speed	0.5 m/s
Cushioning energy	0.01 J
Min. oil content of compressed air	0 mg/m ³
Max. oil content of compressed air	1 mg/m ³
Max. particle size	5 µm
Pressure for determining piston forces with integrated ball rail guide	6,3 bar with integrated ball rail guide

Mini slide, Series MSN

R452000840

Series MSN

2024-08-21

Weight 0.071 kg

Material

Housing material	Aluminum
Surface housing	anodized
Material piston rod	Stainless Steel
Seal material	Polyurethane
Material ball rail table	Aluminum
Surface ball rail table	anodized
Material guide rail	Steel, chrome-plated
Surface guide rail	hardened
Part No.	R452000840

Technical information

The pressure dew point must be at least 15 °C less than ambient and medium temperature and may not exceed 3 °C.

The oil content of compressed air must remain constant during the life cycle.

Use only the approved oils from AVENTICS. Further information can be found in the “Technical information” document (available in <https://www.emerson.com/en-us/support>).

Mini slide, Series MSN

R452000840

Series MSN

2024-08-21

Dimensions

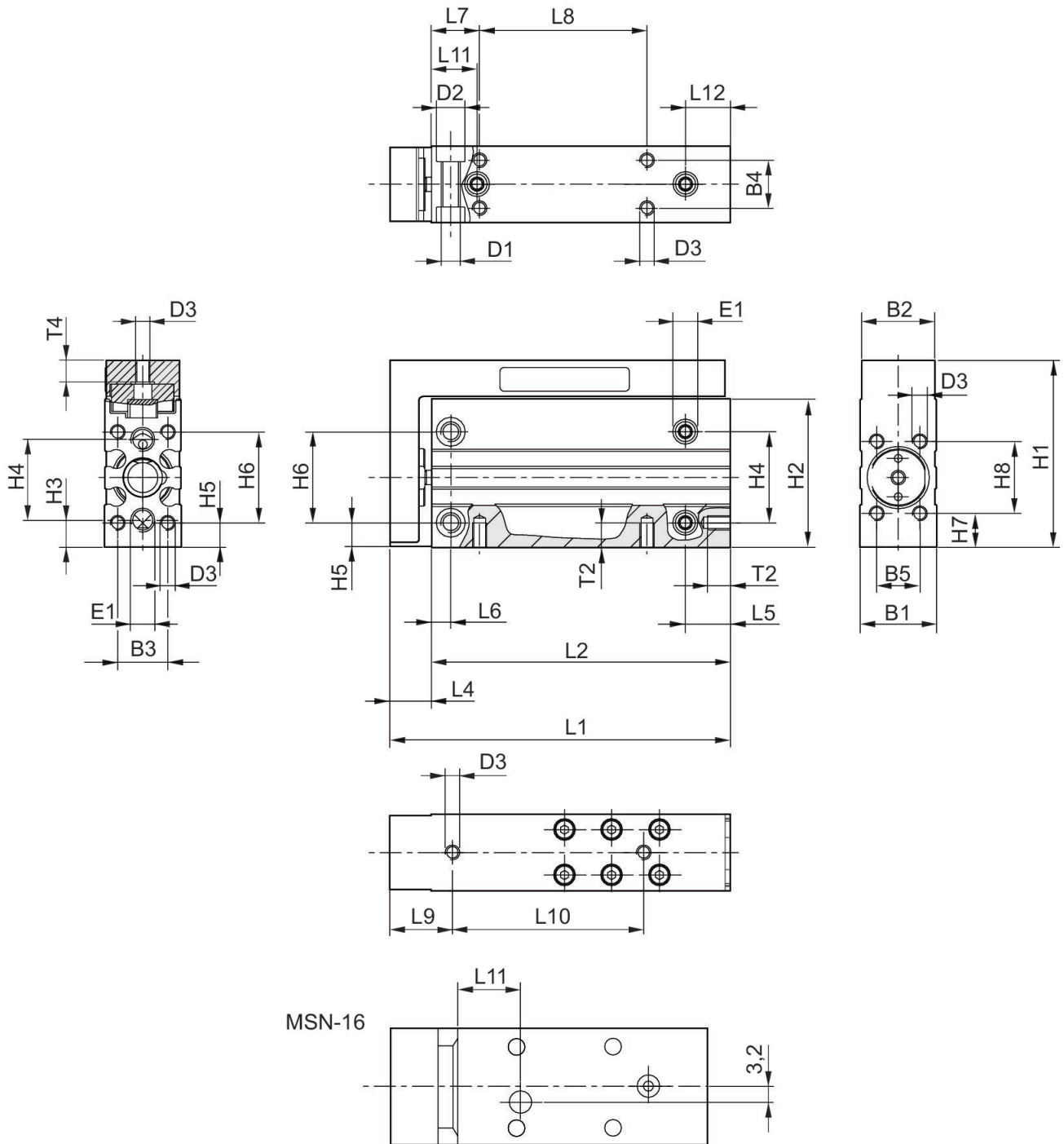

Dimensions

Piston Ø	B1	B2	B3	B4	B5	D1	D2	D3	E1 Compressed air connection
6	16	15.3	10.5	10	9	M4	6	M3	M5
10	20	19.3	13	13	11	M5	7.5	M4	M5

Mini slide, Series MSN

R452000840

Series MSN

2024-08-21

Piston Ø	B1	B2	B3	B4	B5	D1	D2	D3	E1 Compressed air connection
16	24	23.3	17	17	16	M5	7.5	M4	M5

Piston Ø	H1	H2	H3	H4	H5	H6	H7	H8
6	39	31	5.5	17	5	19	7	15
10	45	36	6.5	20	5	23	7.5	18
16	51	41	6	25	5.5	27	6	26

MSN-6

Part No.	Piston Ø	Stroke	L1	L2	L4	L5	L6	L7	L8
R452000840	6	5	46	37.5	8.5	10	4	10	10
R452000841	6	10	51	42.5	8.5	10	4	10	15
R452000842	6	15	56	47.5	8.5	10	4	10	20
R452000843	6	20	61	52.5	8.5	10	4	10	25
R452000844	6	25	66	57.5	8.5	10	4	10	30
R452000845	6	30	71	62.5	8.5	10	4	10	35

Part No.	L9	L10	L11	L12	T2	T4
R452000840	13	20	9.5	9.5	4.8	5
R452000841	13	20	9.5	9.5	4.8	5
R452000842	13	25	9.5	9.5	4.8	5
R452000843	13	30	9.5	9.5	4.8	5
R452000844	13	40	9.5	9.5	4.8	5
R452000845	13	40	9.5	9.5	4.8	5

Correction factor (a, d) vertical

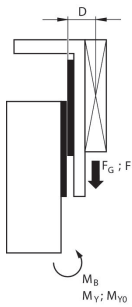

stat.	$M_{B0} = (F_G + F) \cdot D$
dyn.	$M_B = F_G \cdot D$

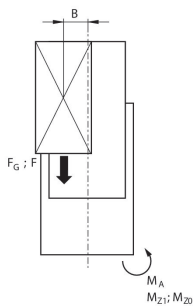

stat.	$M_{A0} = (F_G + F) \cdot B$
dyn.	$M_A = F_G \cdot B$

dyn.	$\frac{M_A}{M_1} + \frac{M_B}{M_2} \leq 1$
stat.	$\frac{M_{A0}}{M_{Z0}} + \frac{M_{B0}}{M_{Y0}} \leq 1$

$F = m \cdot a$ $F_G = m \cdot g$ $a = 1250 \cdot V^2 / H$

F = deceleration force [N] F_G = force due to weight [N] m = load mass [kg] a = deceleration [m/s²] g = gravitational acceleration 9,81 [m/s²] V = velocity [m/s] H = stroke length of shock absorber [mm]

Correction factor (a, d) horizontal

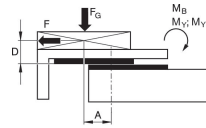

stat.	$M_{B0} = F_G \cdot A + F \cdot D$
dyn.	$M_B = F_G \cdot A$

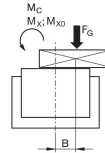

stat.	$M_{C0} = F_G \cdot B$
dyn.	$M_C = F_G \cdot B$

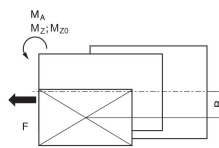

stat.	$M_{A0} = F \cdot B$
dyn.	$M_A = 0$

dyn.	$\frac{M_A}{M_1} + \frac{M_B}{M_2} + \frac{M_C}{M_3} \leq 1$
stat.	$\frac{M_{A0}}{M_{Z0}} + \frac{M_{B0}}{M_{Y0}} + \frac{M_{C0}}{M_{X0}} \leq 1$

$F = m \cdot a$ $F_G = m \cdot g$ $a = 1250 \cdot V^2 / H$

F = deceleration force [N] F_G = force due to weight [N] m = load mass [kg] a = deceleration [m/s²] g = gravitational acceleration 9,81 [m/s²] V = velocity [m/s] H = stroke length of shock absorber [mm]

Correction factor (a, d)

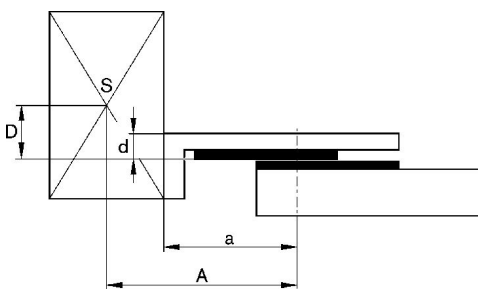

Max. permissible torque

Maximum additionally moving mass (min. stroke, max. stroke) MSN - 6

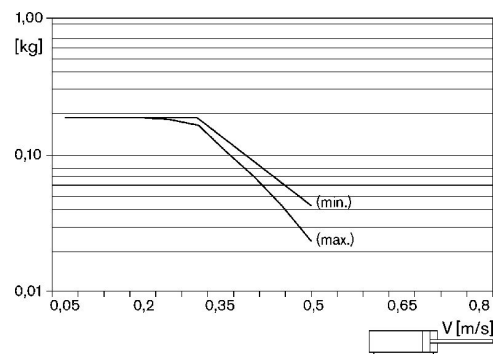

Mini slide, Series MSN

R452000840

Series MSN

2024-08-21

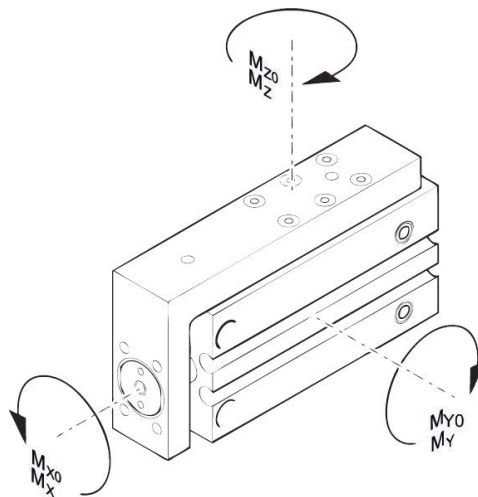

Max. permissible torque

Part No.	Piston Ø	Stroke	a [mm]	d [mm]	Mx0 Static moment M [Nm]	My0 Static moment M [Nm]	Mz0 Static moment M [Nm]	Mx Dynam-ic moment M [Nm]	My Dynam-ic moment M [Nm]
R452000840	6	5	27	6	1.3	0.6	0.6	0.35	0.4
R452000841	6	10	32	6	1.3	0.6	0.6	0.35	0.4
R452000842	6	15	32	6	1.3	0.6	0.6	0.35	0.4
R452000843	6	20	37	6	1.3	0.6	0.6	0.35	0.4
R452000844	6	25	42	6	1.3	0.6	0.6	0.35	0.4
R452000845	6	30	47	6	1.3	0.6	0.6	0.35	0.4
R452000846	10	5	31	6.8	2.3	2.4	2.4	0.6	0.8
R452000847	10	10	36	6.8	2.3	2.4	2.4	0.6	0.8
R452000848	10	15	41	6.8	2.3	2.4	2.4	0.6	0.8
R452000849	10	20	41	6.8	2.3	2.4	2.4	0.6	0.8
R452000850	10	25	48	6.8	2.3	2.4	2.4	0.6	0.8
R452000851	10	30	53	6.8	2.3	2.4	2.4	0.6	0.8
R452000852	16	5	40	7.5	7.3	4.3	4.3	1.8	2
R452000853	16	10	40	7.5	7.3	4.3	4.3	1.8	2
R452000854	16	15	50	7.5	7.3	4.3	4.3	1.8	2
R452000855	16	20	50	7.5	7.3	4.3	4.3	1.8	2
R452000856	16	25	55	7.5	7.3	4.3	4.3	1.8	2
R452000857	16	30	60	7.5	7.3	4.3	4.3	1.8	2

Part No.	Mz Dynam-ic moment M [Nm]
R452000840	0.4
R452000841	0.4
R452000842	0.4
R452000843	0.4
R452000844	0.4

Mini slide, Series MSN

R452000840

Series MSN

2024-08-21

Part No.	Mz Dynamic moment M [Nm]
R452000845	0.4
R452000846	0.8
R452000847	0.8
R452000848	0.8
R452000849	0.8
R452000850	0.8
R452000851	0.8
R452000852	2
R452000853	2
R452000854	2
R452000855	2
R452000856	2
R452000857	2

Overview drawing

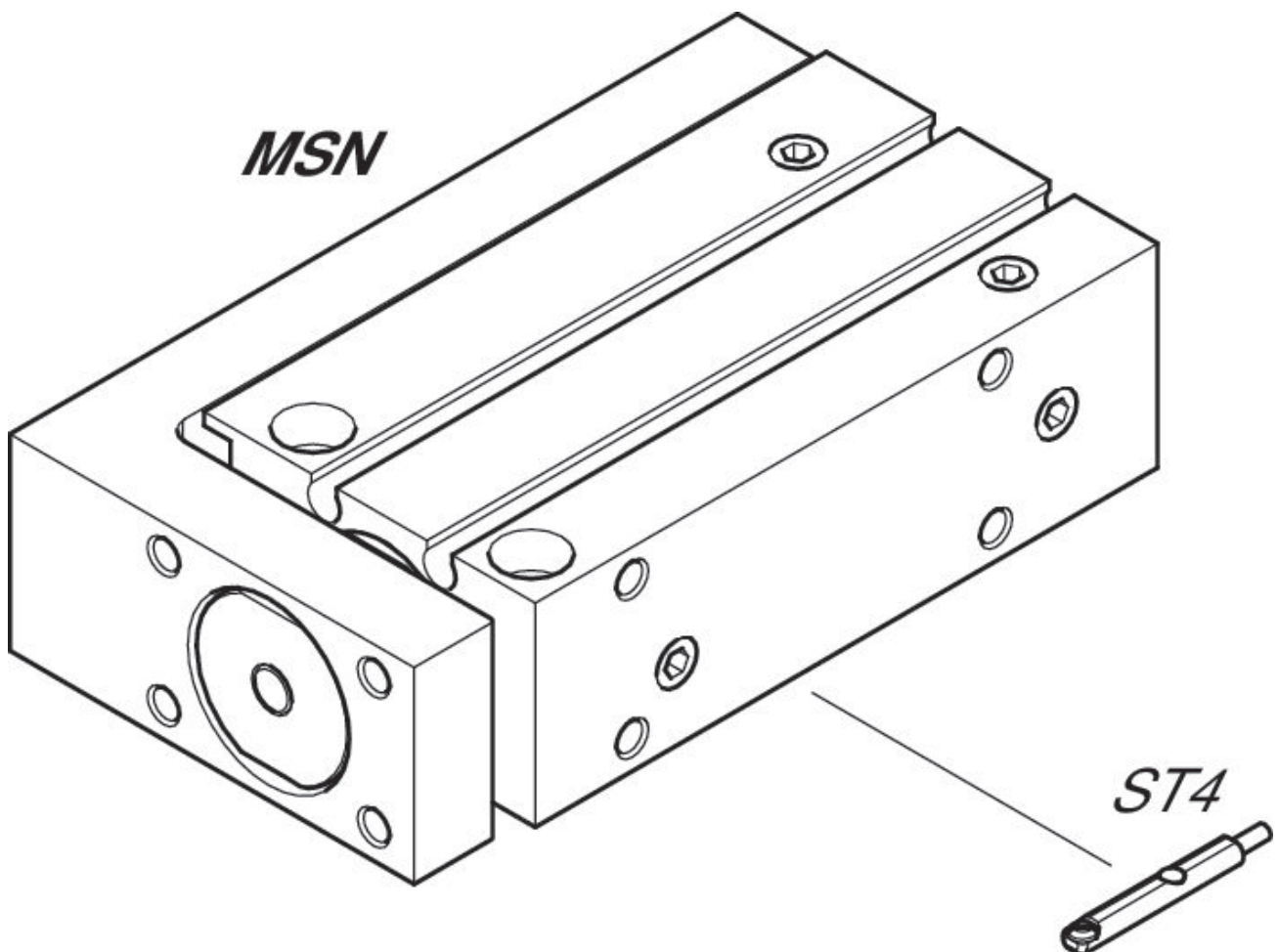

NOTE: This overview drawing is only for orientation to indicate where the various accessory parts can be fastened to the cylinder. The illustration has been simplified for this purpose. It is thus not possible to derive the dimensions from this overview.