

Gabel, abnehmbar (Befestigung MP2)

R432013402

Gabelbefestigung

2025-12-03

AVENTICS Gabelbefestigungen



Technische Daten

Branche	Industrie
Normierung	NFPA
geeigneter Kolbendurchmesser	101.6 mm
Lieferumfang	Gabelbefestigung inkl. Bolzen und Befestigungsschrauben
Gewicht	1.09 kg

Werkstoff

Werkstoff	Aluminium
Materialnummer	R432013402

Abmessungen

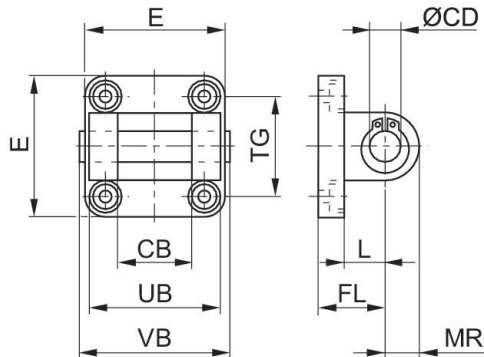

Abmessungen in inch

Materialnummer	Ø	CB H14	Ø CD H9	E	FL	L	MR	UB	VB	TG
R432013371	1.5	0.75	0.500	2.00	1.13	0.75	0.53	-	-	-
R432008309	1.5	0.75	0.500	2.00	1.13	0.75	0.69	-	-	-
R432012512	2.0	0.75	0.500	2.50	1.13	0.75	0.53	-	-	-
R432008305	2.0	0.75	0.500	2.50	1.13	0.75	0.53	-	-	-
R432013379	2.5	0.75	0.500	3.00	1.13	0.75	0.53	-	-	-
R432008306	2.5	0.75	0.500	3.00	1.13	0.75	0.53	-	-	-
R432013394	3.25	1.25	0.750	3.75	1.87	1.31	0.88	-	-	-
R432008307	3.25	1.25	0.750	3.75	1.88	1.25	1.00	-	-	-
R432013402	4.0	1.25	0.750	4.50	1.88	1.25	0.78	-	-	-
R432008308	4.0	1.25	0.750	4.50	1.88	1.25	1.00	-	-	-