

Fissaggio a flangia, Serie MF1, MF2

R432013396

Fissaggi a
flangia

2023-11-14

Montajes de brida AVENTICS



Dati tecnici

Settore	Industria
Normalizzazione	NFPA
Diametro pistone	101.6 mm
Peso	0.508 kg

Materiale

Materiale corpo	Alluminio
Codice	R432013396
Dimensioni in pollici	

Fissaggio a flangia, Serie MF1, MF2

R432013396

Fissaggi a
flangia

2023-11-14

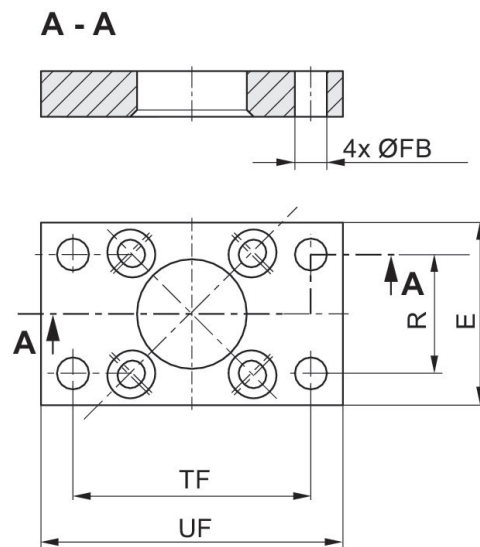

Dimensioni in pollici

Codice	Ø	E	Ø FB	R	TF	UF
R432013373	38.1	2.00	0.34	1.43	2.75	3.38
R432012520	50.8	2.50	0.41	1.84	3.38	4.13
R432013382	63.5	3.00	0.41	2.19	3.88	4.63
R432013388	82.55	3.50	0.47	2.76	4.69	5.50
R432013396	101.6	4.50	0.47	3.32	5.44	6.25