

AVENTICS Flanschbefestigungen



Technische Daten

Branche	Industrie
Normierung	NFPA
geeigneter Kolbendurchmesser	101.6 mm
Gewicht	0.508 kg

Werkstoff

Werkstoff Gehäuse	Aluminium
Materialnummer	R432013396
Abmessungen in inch	

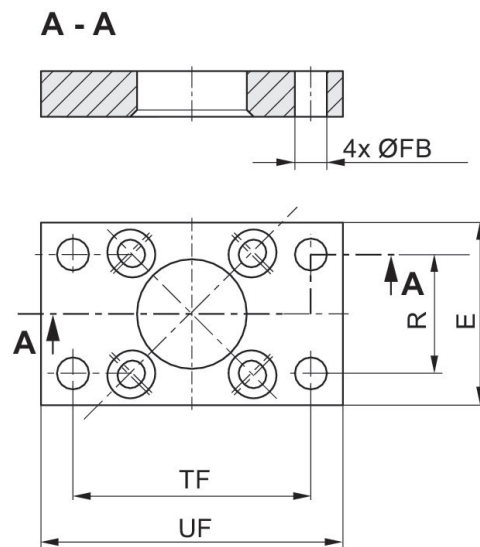

Abmessungen in inch

Material-nummer	Ø	E	Ø FB	R	TF	UF
R432013373	38.1	2.00	0.34	1.43	2.75	3.38
R432012520	50.8	2.50	0.41	1.84	3.38	4.13
R432013382	63.5	3.00	0.41	2.19	3.88	4.63
R432013388	82.55	3.50	0.47	2.76	4.69	5.50
R432013396	101.6	4.50	0.47	3.32	5.44	6.25