

Detachable Clevis (MP2 mount)

R432013394

Clevis
mounting

2025-12-03

AVENTICS Clevis mountings



Technical data

Industry	Industrial
Standardization	NFPA
Piston diameter	82.55 mm
Scope of delivery	Clevis mounting incl. pivot pins and mounting screws
Weight	0.508 kg

Material

Material	Aluminum
Part No.	R432013394

Detachable Clevis (MP2 mount)

R432013394

Clevis
mounting

2025-12-03

Dimensions

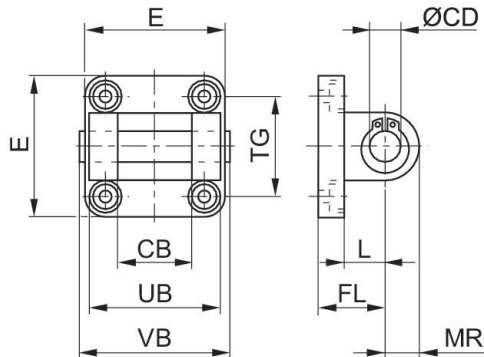

Dimensions in inches

Part No.	Ø	CB H14	Ø CD H9	E	FL	L	MR	UB	VB	TG
R432013371	1.5	0.75	0.500	2.00	1.13	0.75	0.53	-	-	-
R432008309	1.5	0.75	0.500	2.00	1.13	0.75	0.69	-	-	-
R432012512	2.0	0.75	0.500	2.50	1.13	0.75	0.53	-	-	-
R432008305	2.0	0.75	0.500	2.50	1.13	0.75	0.53	-	-	-
R432013379	2.5	0.75	0.500	3.00	1.13	0.75	0.53	-	-	-
R432008306	2.5	0.75	0.500	3.00	1.13	0.75	0.53	-	-	-
R432013394	3.25	1.25	0.750	3.75	1.87	1.31	0.88	-	-	-
R432008307	3.25	1.25	0.750	3.75	1.88	1.25	1.00	-	-	-
R432013402	4.0	1.25	0.750	4.50	1.88	1.25	0.78	-	-	-
R432008308	4.0	1.25	0.750	4.50	1.88	1.25	1.00	-	-	-