

Gabel, abnehmbar (Befestigung MP2)

R432013394

Gabelbefestigung

2025-12-03

AVENTICS Gabelbefestigungen



Technische Daten

Branche	Industrie
Normierung	NFPA
geeigneter Kolbendurchmesser	82.55 mm
Lieferumfang	Gabelbefestigung inkl. Bolzen und Befestigungsschrauben
Gewicht	0.508 kg

Werkstoff

Werkstoff	Aluminium
Materialnummer	R432013394

Abmessungen

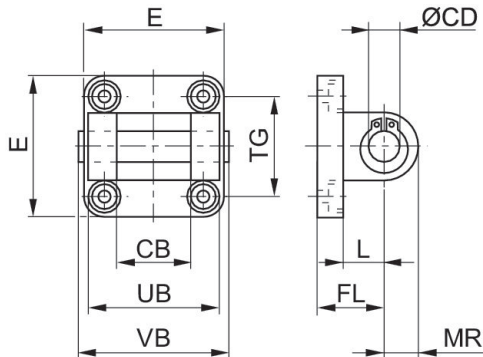

Abmessungen in inch

Materialnummer	Ø	CB H14	Ø CD H9	E	FL	L	MR	UB	VB	TG
R432013371	1.5	0.75	0.500	2.00	1.13	0.75	0.53	-	-	-
R432008309	1.5	0.75	0.500	2.00	1.13	0.75	0.69	-	-	-
R432012512	2.0	0.75	0.500	2.50	1.13	0.75	0.53	-	-	-
R432008305	2.0	0.75	0.500	2.50	1.13	0.75	0.53	-	-	-
R432013379	2.5	0.75	0.500	3.00	1.13	0.75	0.53	-	-	-
R432008306	2.5	0.75	0.500	3.00	1.13	0.75	0.53	-	-	-
R432013394	3.25	1.25	0.750	3.75	1.87	1.31	0.88	-	-	-
R432008307	3.25	1.25	0.750	3.75	1.88	1.25	1.00	-	-	-
R432013402	4.0	1.25	0.750	4.50	1.88	1.25	0.78	-	-	-
R432008308	4.0	1.25	0.750	4.50	1.88	1.25	1.00	-	-	-