

Montajes de brida AVENTICS



Datos técnicos

Sector	Industria
Normalización	NFPA
Diámetro de émbolo	63.5 mm
Peso	0.0544 kg

Material

Material carcasa	Aluminio
Nº de material	R432013382
Dimensiones en pulgadas	

Fijación por brida, Serie MF1, MF2

R432013382

Fijaciones
por brida

2023-11-14

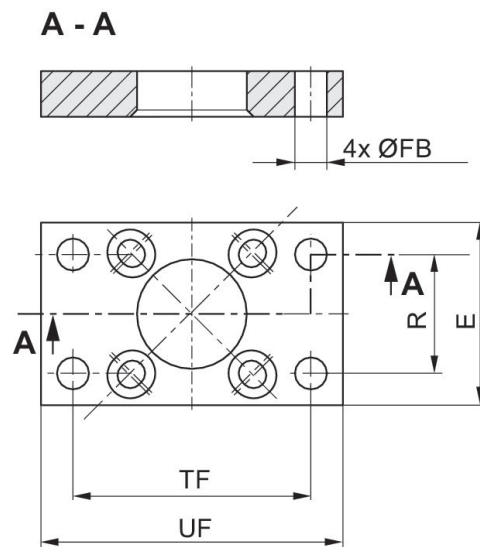

Dimensiones en pulgadas

N° de material	Ø	E	Ø FB	R	TF	UF
R432013373	38.1	2.00	0.34	1.43	2.75	3.38
R432012520	50.8	2.50	0.41	1.84	3.38	4.13
R432013382	63.5	3.00	0.41	2.19	3.88	4.63
R432013388	82.55	3.50	0.47	2.76	4.69	5.50
R432013396	101.6	4.50	0.47	3.32	5.44	6.25