

Gabel, abnehmbar (Befestigung MP2)

R432013379

Gabelbefestigung

2025-12-03

AVENTICS Gabelbefestigungen



Technische Daten

Branche	Industrie
Normierung	NFPA
geeigneter Kolbendurchmesser	63.5 mm
Lieferumfang	Gabelbefestigung inkl. Bolzen und Befestigungsschrauben
Gewicht	0.0544 kg

Werkstoff

Werkstoff	Aluminium
Materialnummer	R432013379

Abmessungen

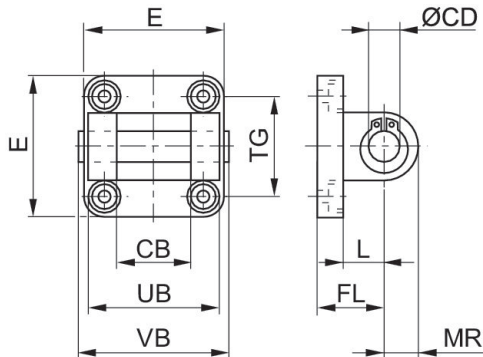

Abmessungen in inch

Materialnummer	Ø	CB H14	Ø CD H9	E	FL	L	MR	UB	VB	TG
R432013371	1.5	0.75	0.500	2.00	1.13	0.75	0.53	-	-	-
R432008309	1.5	0.75	0.500	2.00	1.13	0.75	0.69	-	-	-
R432012512	2.0	0.75	0.500	2.50	1.13	0.75	0.53	-	-	-
R432008305	2.0	0.75	0.500	2.50	1.13	0.75	0.53	-	-	-
R432013379	2.5	0.75	0.500	3.00	1.13	0.75	0.53	-	-	-
R432008306	2.5	0.75	0.500	3.00	1.13	0.75	0.53	-	-	-
R432013394	3.25	1.25	0.750	3.75	1.87	1.31	0.88	-	-	-
R432008307	3.25	1.25	0.750	3.75	1.88	1.25	1.00	-	-	-
R432013402	4.0	1.25	0.750	4.50	1.88	1.25	0.78	-	-	-
R432008308	4.0	1.25	0.750	4.50	1.88	1.25	1.00	-	-	-