

Manifold strip

R422000946



Technical data

Industry
Industrial

Type
Manifold strip

Nominal flow Qn
1500 l/min

Min. ambient temperature
-10 °C

Max. number of valve positions
6

For series
TC15

Type
Manifold strip

Max. ambient temperature
50 °C

Medium
Compressed air

Weight
0.474 kg

Material

Material base plate
Aluminum

Seal material
Acrylonitrile butadiene rubber

Part No.
R422000946

Technical information

The min. control pressure must be adhered to, since otherwise faulty switching and valve failure may result!

The pressure dew point must be at least 15 °C under ambient and medium temperature and may not exceed 3 °C .

The oil content of compressed air must remain constant during the life cycle.

Use only the approved oils from AVENTICS. Further information can be found in the "Technical information" document (available in <https://www.emerson.com/en-us/support>).

Dimensions

p-strip with support bracket

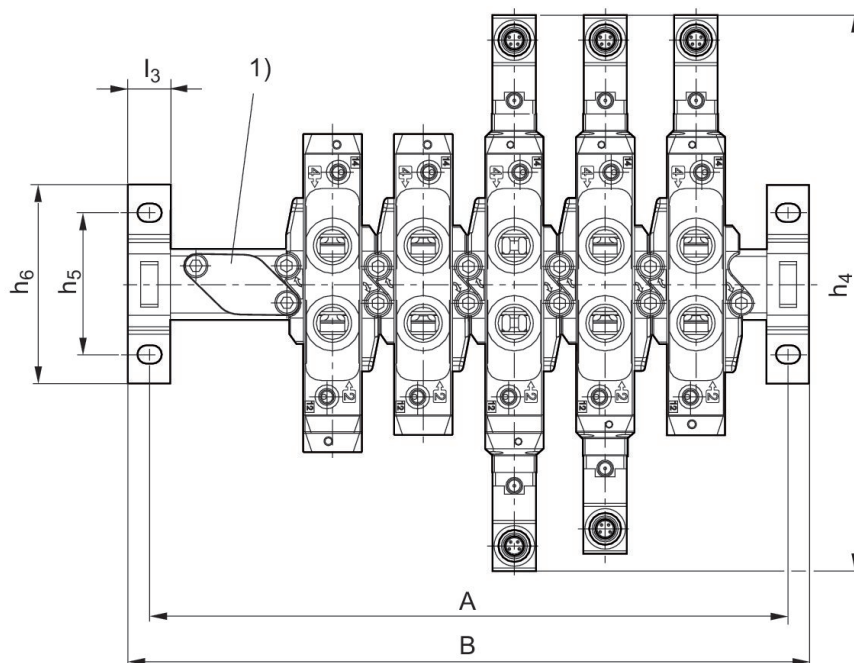
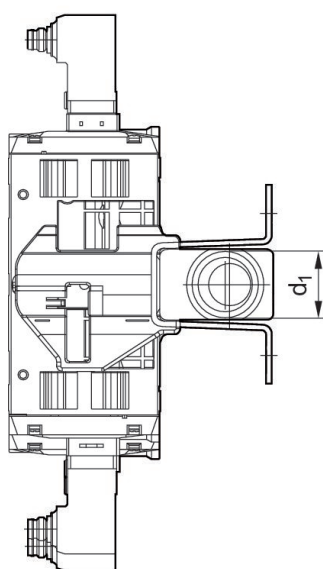
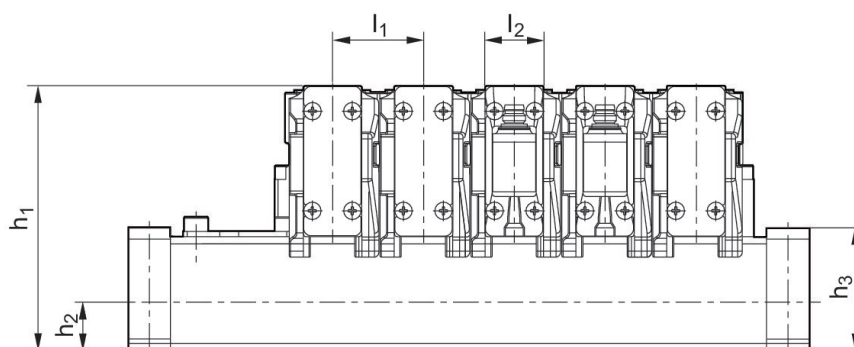

Part No.	n	A	B	d1	h1	h2	h3	h4	h5
R422000942	2	97	112	G 1/2	93,2	17	43,1	195,6	50
R422000943	3	129	144	G 1/2	93,2	17	43,1	195,6	50
R422000944	4	161	176	G 1/2	93,2	17	43,1	195,6	50
R422000945	5	193	208	G 1/2	93,2	17	43,1	195,6	50
R422000946	6	225	240	G 1/2	93,2	17	43,1	195,6	50
R412012680	8	289	304	G 1/2	93,2	17	43,1	195,6	50
R412012681	10	353	368	G 1/2	93,2	17	43,1	195,6	50

h6	l1	l2	l3
70	32	21	15
70	32	21	15
70	32	21	15
70	32	21	15
70	32	21	15
70	32	21	15
70	32	21	15

n = number of valve positions

Dimensions

P-strip with mounting bracket

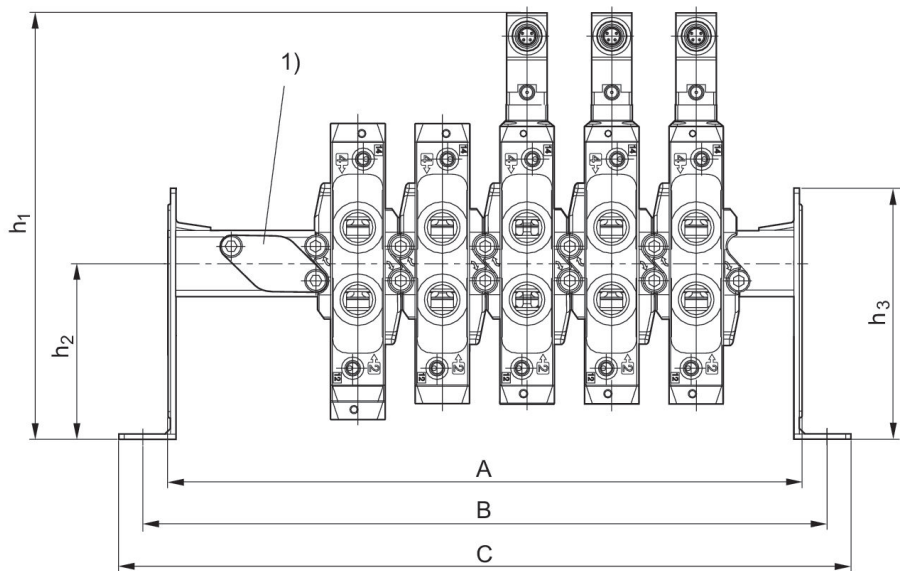
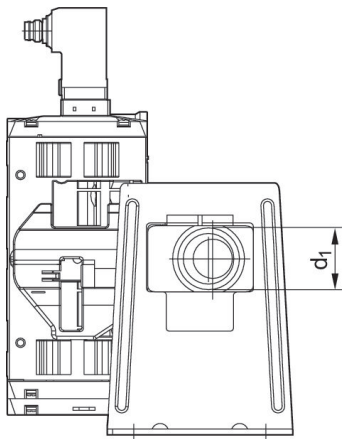
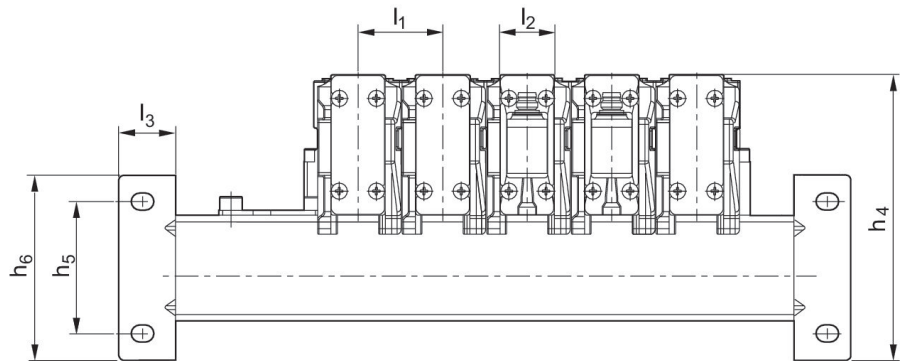

Part No.	n	A	B	C	d1	h1	h2	h3	h4
R422000942	2	112	131	149	G 1/2	161,3	66,5	95	108
R422000943	3	144	163	181	G 1/2	161,3	66,5	95	108
R422000944	4	176	195	213	G 1/2	161,3	66,5	95	108
R422000945	5	208	227	245	G 1/2	161,3	66,5	95	108
R422000946	6	240	259	277	G 1/2	161,3	66,5	95	108
R412012680	8	304	323	341	G 1/2	161,3	66,5	95	108
R412012681	10	368	387	405	G 1/2	161,3	66,5	95	108

h5	h6	l1	l2	l3
50	70	32	21	21,5
50	70	32	21	21,5
50	70	32	21	21,5
50	70	32	21	21,5

h5	h6	l1	l2	l3
50	70	32	21	21,5
50	70	32	21	21,5
50	70	32	21	21,5

n = number of valve positions

Dimensions

P-strip with mounting bracket

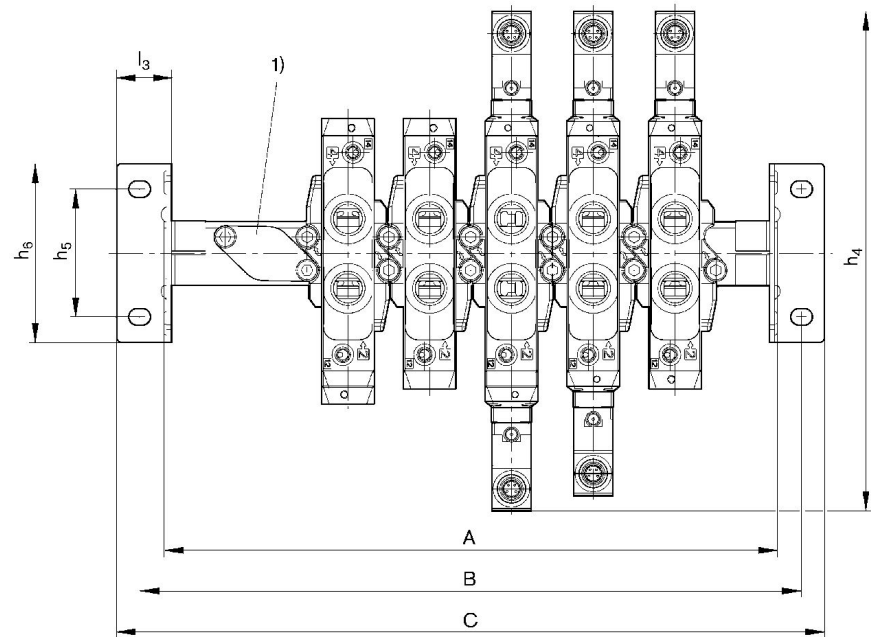
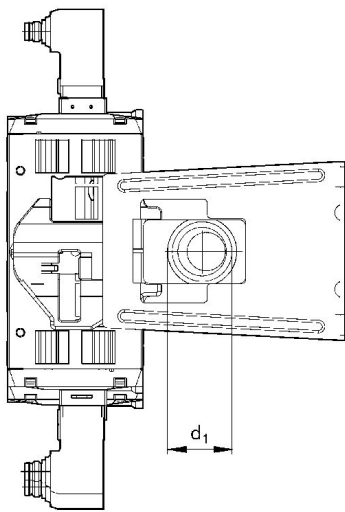
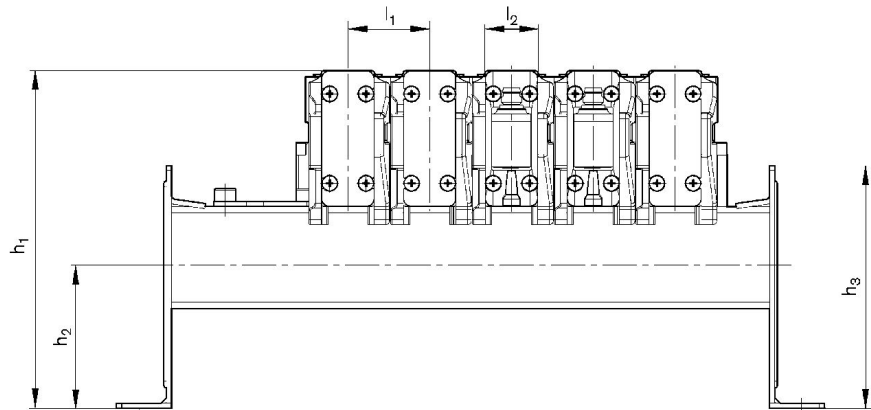

Part No.	n	A	B	C	d1	h1	h2	h3	h4
R422000942	2	112	131	149	G 1/2	132,2	56	95	195,6
R422000943	3	144	163	181	G 1/2	132,2	56	95	195,6

Part No.	n	A	B	C	d1	h1	h2	h3	h4
R422000944	4	176	195	213	G 1/2	132,2	56	95	195,6
R422000945	5	208	227	245	G 1/2	132,2	56	95	195,6
R422000946	6	240	259	277	G 1/2	132,2	56	95	195,6
R412012680	8	304	323	341	G 1/2	132,2	56	95	195,6
R412012681	10	368	387	405	G 1/2	132,2	56	95	195,6

h5	h6	l1	l2	l3
50	70	32	21	21,5
50	70	32	21	21,5
50	70	32	21	21,5
50	70	32	21	21,5
50	70	32	21	21,5
50	70	32	21	21,5
50	70	32	21	21,5

n = number of valve positions

Dimensions

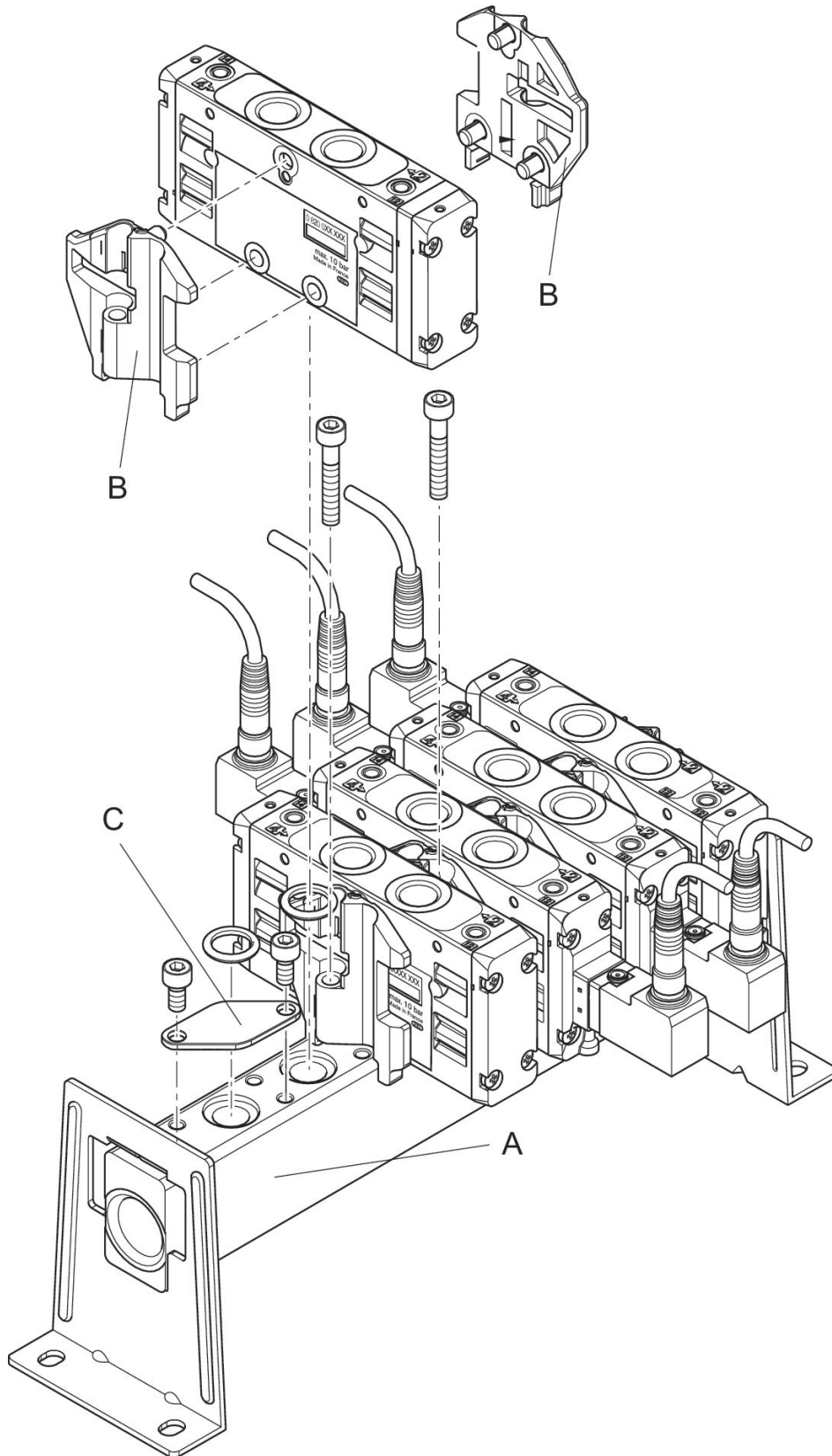

The following must be ordered to mount the valves: manifold strip A and mounting kit B
C = Blanking plate

Part No.	
R422000942	A
R422000943	A
R422000944	A
R422000945	A
R422000946	A
R422000947	B
R422000938	C
R412012680	A
R412012681	A

Dimensions

