

ED07 series proportional pressure regulator, EtherCAT

R414014313

General series information Series ED07

- The AVENTICS Series ED07 offers proportional pressurization and the exhaust valves are controlled separately to deliver dynamic control for the most demanding applications.
- Highly dynamic proportional pressure regulator
- Stackable with base plate
- Nominal width 7
- Flow 1300 l/min
- Pressure range -1 ... 20 bar
- EtherCAT, AES fieldbus connection

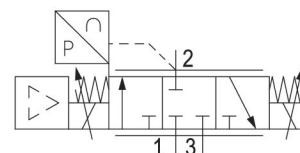

Technical data

Control
EtherCAT

Regulation range min.
0 bar

Regulation range max.
10 bar

Working pressure min.
0.5 bar

Working pressure max.
12 bar

Hysteresis
< [[0,03] bar]

Medium
Compressed air

Nominal flow Q_n
1300 l/min

Min. ambient temperature
5 °C

Max. ambient temperature
50 °C

Min. medium temperature
5 °C

Max. medium temperature
50 °C

DC operating voltage
24 V

Permissible ripple
5%

Max. power consumption
1400 mA

Protection class
IP65

Max. particle size 50 µm	Signal connection input and output
Oil content of compressed air min. 0 mg/m ³	Signal connection Plug
Oil content of compressed air max. 1 mg/m ³	Signal connection M12
Type Poppet valve	Signal connection 5-pin
Mounting orientation $\alpha = 0 \dots 90^\circ \pm \beta = 0 \dots 90^\circ$	Industry Industrial
Certificates CE declaration of conformity	Weight 2.05 kg

Material

Housing material Die-cast aluminum	Material base plate Aluminum
Seal material Hydrogenated acrylonitrile butadiene rubber	Part No. R414014313

Technical information

With oil-free, dry air, other installation positions are possible on request.

The protection class is only ensured when the plug is mounted properly. For detailed information, see operating instructions.

The min. control pressure must be adhered to, since otherwise faulty switching and valve failure may result!

The pressure dew point must be at least 15 °C under ambient and medium temperature and may not exceed 3 °C .

The oil content of compressed air must remain constant during the life cycle.

Use only the approved oils from AVENTICS. Further information can be found in the “Technical information” document (available in <https://www.emerson.com/en-us/support>).

Dimensions

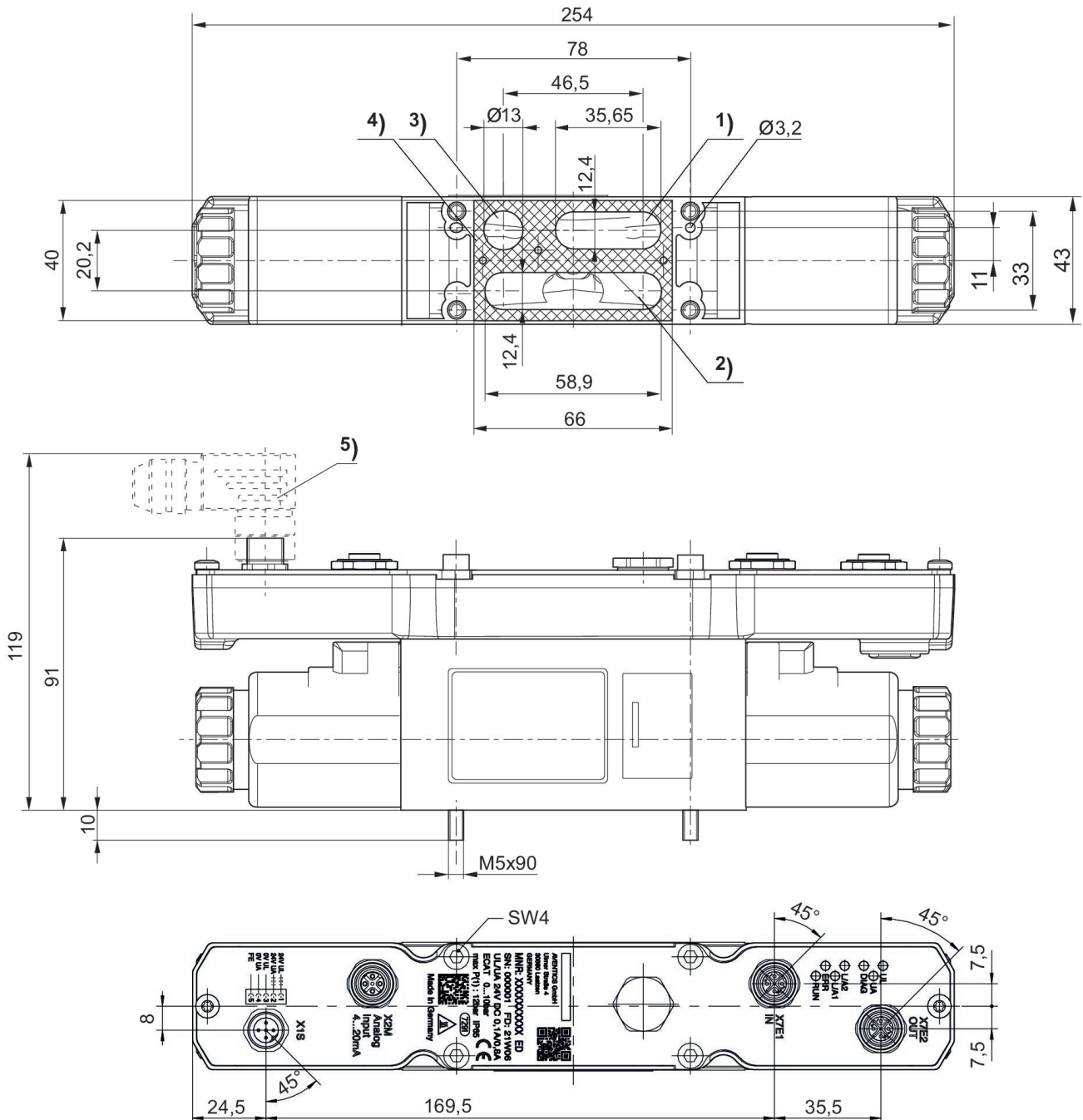

- 1) Operating pressure
- 2) Working pressure
- 3) Exhaust
- 4) Flat gasket
- 5) Accessories not supplied

Mounting orientation

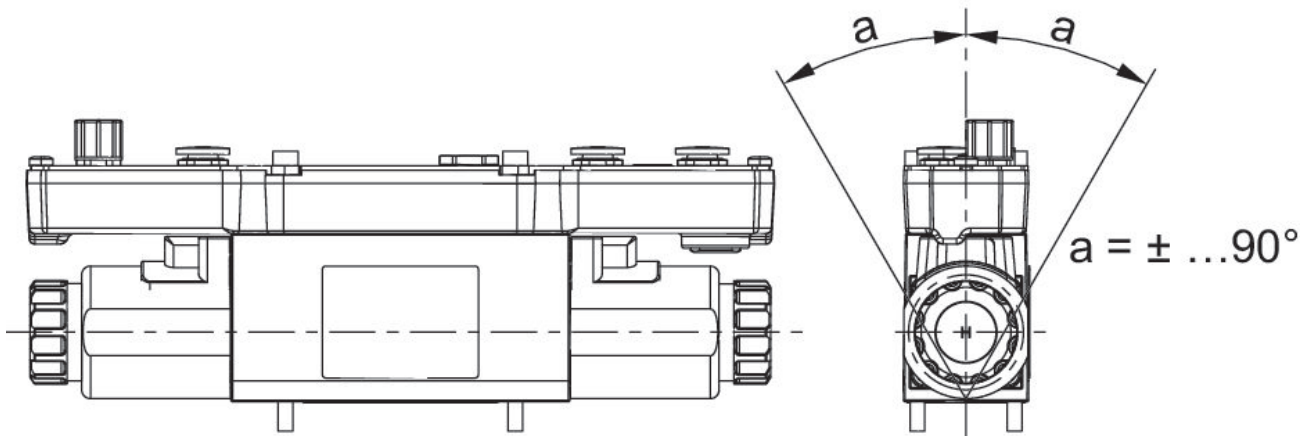

Flow diagram

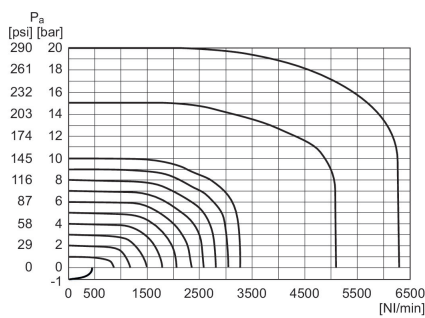

Pa = Working pressure

Functional diagram

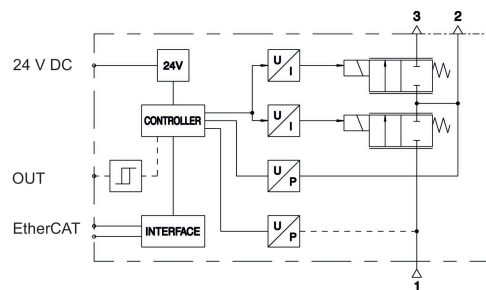

- 1) Input
- 2) Output
- 3) Exhaust

Plug X1S

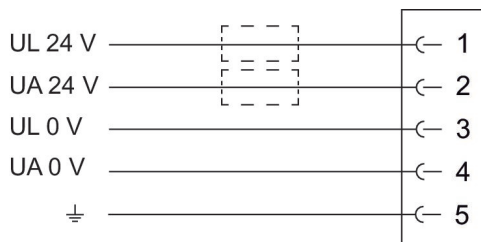

Sensor round plug M12x1, 5-pin, integrated plug, A-coded
Only use a power pack with safe isolation for power supply (electronics and actuator power).

Plug X20

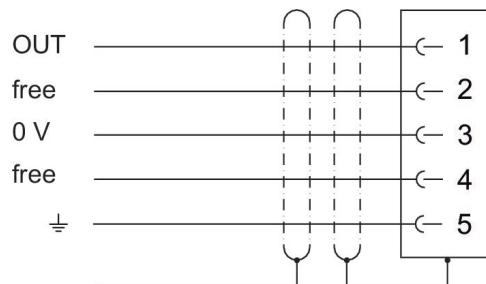

Sensor round plug M12x1, 5-pin, integrated socket, A-coded
The ground for plug X20 PIN 5 and the shielding for plugs X7E1 / X7E2 and X20 are directly connected to the housing. The device must be mounted on a grounded mounting plate.

Plug X7E1, X7E2

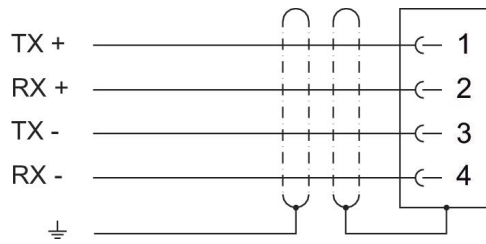

Ethernet plug M12x1, 4-pin, socket, D-coded
The Ethernet cables must be shielded.