

- High flow rate with compact dimensions
- Easy to assemble
- Low weight
- Configuration available
- Different electrical connections available
- Analog or I/O-link control options
- Can be mounted on standard AV03 and AV05 valve manifolds (AVENTICS Series AV-EP)

AVENTICS EV03 Pilot-Operated Proportional Control Valve

The AVENTICS EV03 pilot-operated proportional control valve is ideal for applications requiring infrequent pressure adjustments. It works according to the indirect control principle with pilot valves. In the event of power loss and thus a failure of the electrical control, mechanical pressure control is maintained by the pressure in the pilot volumes, even if air escapes from the main valve. The EV03 is optimally suited for static conditions with only occasional set point changes. A key feature of the valve is its extremely low energy consumption. It can be mounted on AV03 or AV05 valve manifolds to minimize wiring, plumbing and space requirements.

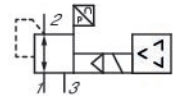

Technical data

Type

Archive product: Do not use in new constructions!

Control

Analog

Function

Pressure-holding

Basic valve equipment

Basic valve without base plate

Min. regulation range

0.5 bar

Max. regulation range

10 bar

Min. working pressure

0 bar

Max. working pressure

11 bar

Hysteresis

< 0,2 bar

Repetitive precision

< 0,18 bar

Medium

Compressed air

Nominal flow Qn

550 l/min

Min. ambient temperature

-10 °C

Max. ambient temperature

60 °C

Min. medium temperature

-10 °C

Max. medium temperature

60 °C

Operational voltage DC

24 V

Max. current consumption

120 mA

Protection class

IP65

EV03 series proportional pressure regulator

Series
EV03

R414009021

2024-11-05

Display	LED
Permissible ripple	5%
Max. particle size	40 µm
Min. oil content of compressed air	0 mg/m ³
Max. oil content of compressed air	5 mg/m ³
Type	Poppet valve
Mounting orientation	Any
Compressed air connection input	G 1/4
Compressed air connection output	G 1/4
Compressed air connection, exhaust	G 1/4
Electrical connection size	M12
Electrical connection number of poles	5-pin
Electrical connection coding	A-coded
Actual output value	4 ... 20 mA
Nominal input value	4 ... 20 mA
Pilot control exhaust	With collective pilot air exhaust
Industry	Industrial
Weight	0.21 kg

Material

Housing material	Polyarylamide
Seal material	Nitrile butadiene rubber
Part No.	R414009021

Technical information

Nominal flow Q_n with working pressure 7 bar, with secondary pressure 6 bar and $\Delta p = 0.2$ bar
The min. control pressure must be adhered to, since otherwise faulty switching and valve failure may result!

The pressure dew point must be at least 15 °C less than ambient and medium temperature and may not exceed 3 °C.

The oil content of compressed air must remain constant during the life cycle.

Use only the approved oils from AVENTICS. Further information can be found in the "Technical information" document (available in <https://www.emerson.com/en-us/support>).

EV03 series proportional pressure regulator

R414009021

Series
EV03

2024-11-05

Dimensions

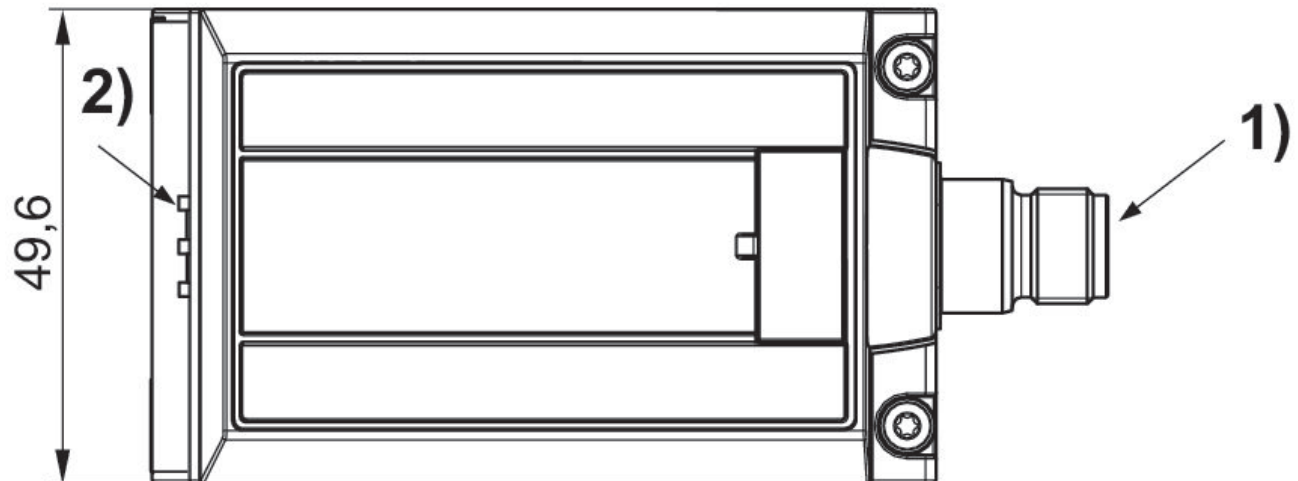
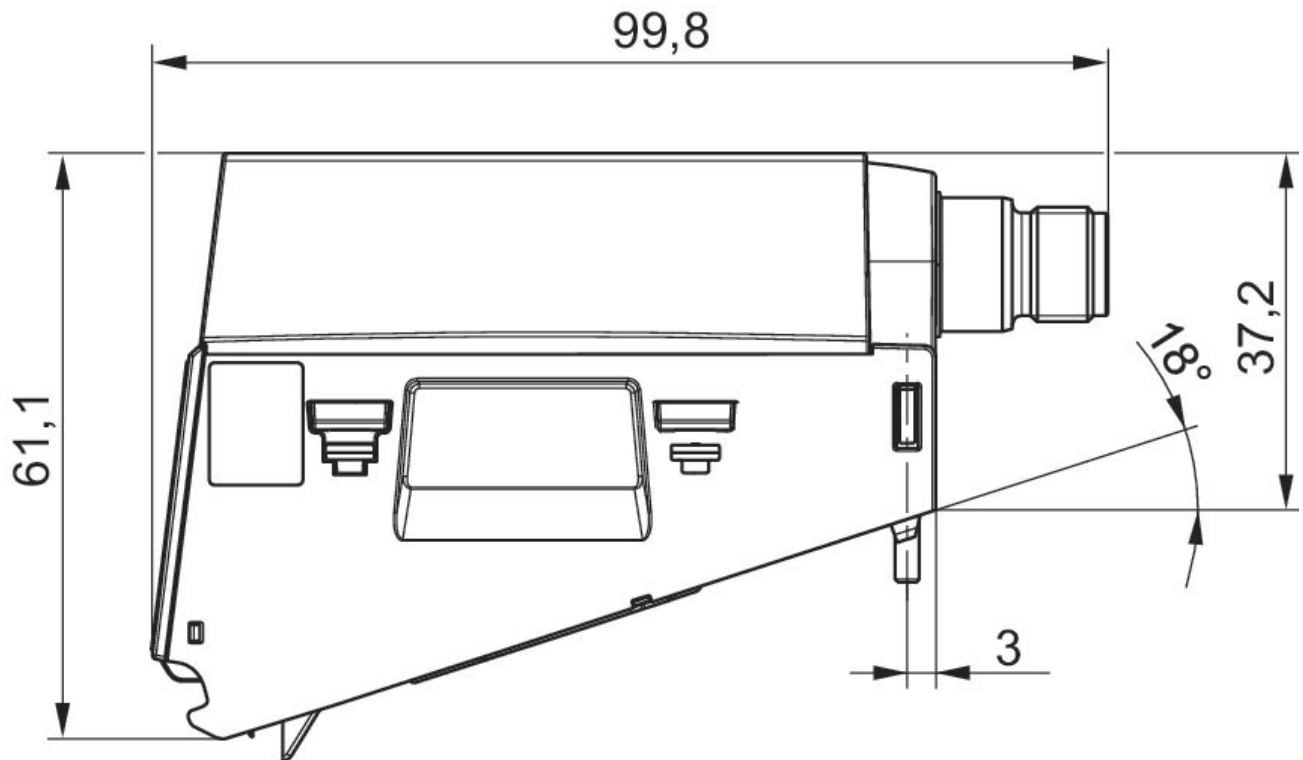

- 1) Port for plug M12x1
- 2) LED status display

Flow characteristic curve

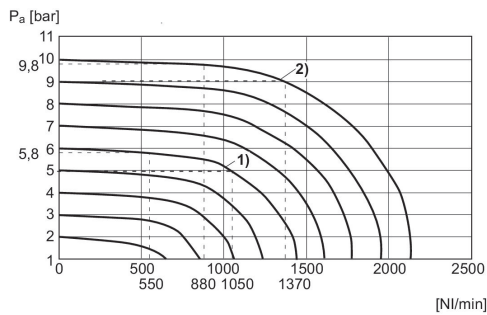

- 1) $P_v = [[7] \text{ bar}]$
- 2) $P_v = [[11] \text{ bar}]$
- $P_v = \text{Supply pressure}$
- $P_a = \text{Working pressure}$
- $P_v = P_a + 1$

Characteristic and pin assignment for current and voltage control with actual output value

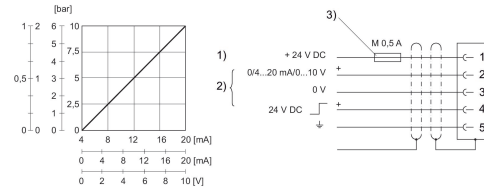

- 1) Operational voltage
- 2) Nominal value (pin 2) and switch output (pin 4) are related to 0 V. Acknowledge signal
- 3) The operating voltage must be protected by an external M 0.5 A fuse.

Fig. 2 Characteristic and pin assignment for voltage control with actual output value

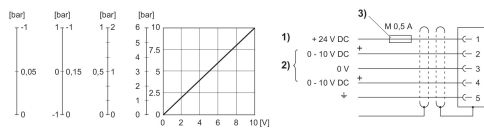

- 1) Supply voltage 2) Actual value (pin 4) and nominal value (pin 2) are related to 0 V. Min. load resistance of nominal value output = 1 kΩ. 3) The operating voltage must be protected by an external M 0.5 A fuse. Connect the plug via a shielded cable to ensure EMC.

Characteristic and pin assignment for current control with actual output value

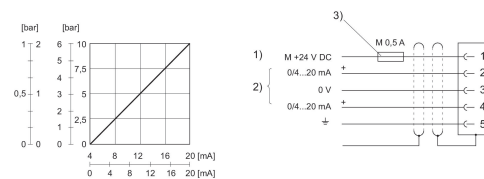

- 1) power supply
- 2) Actual value (pin 4) and nominal value (pin 2) are related to 0 V (pin 3). Nominal input value (ohmic load 100 Ω), actual output value: external ohmic load < 300 Ω. If the power supply is switched off, the nominal input value is high-ohmic.
- 3) The power supply must be protected by an external M 0.5 A fuse. Connect the plug via a shielded cable to ensure EMC.