

EV03 series proportional pressure regulator

R414008245

General series information
AVENTICS EV03 Pilot-Operated Proportional Control Valve

- The AVENTICS EV03 pilot-operated proportional control valve is ideal for applications requiring infrequent pressure adjustments. It works according to the indirect control principle with pilot valves. In the event of power loss and thus a failure of the electrical control, mechanical pressure control is maintained by the pressure in the pilot volumes, even if air escapes from the main valve. The EV03 is optimally suited for static conditions with only occasional set point changes. A key feature of the valve is its extremely low energy consumption. It can be mounted on AV03 or AV05 valve manifolds to minimize wiring, plumbing and space requirements.

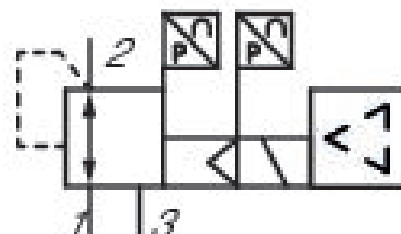
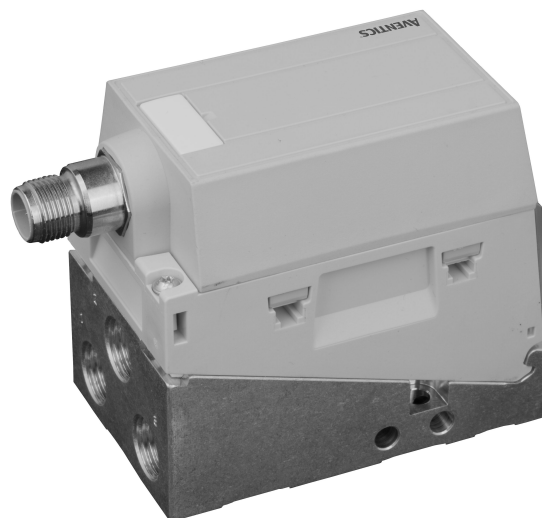

Technical data

Control	Analog
Function	Pressure-holding, with switch output
basic valve with electrical connector	Basic valve with base plate
Regulation range min.	0.5 bar
Regulation range max.	6 bar
Working pressure min.	0 bar
Working pressure max	11 bar
Hysteresis	< 0,05 bar
Repetitive precision	< 0,04 bar
Medium	Compressed air
Nominal flow Qn	550 l/min
Min. ambient temperature	-10 °C

Max. ambient temperature	60 °C
Min. medium temperature	-10 °C
Max. medium temperature	60 °C
DC operating voltage	24 V
Max. current consumption	120 mA
Protection class	IP65
Display	LED
Permissible ripple	5%
Max. particle size	40 µm
Oil content of compressed air min.	0 mg/m ³
Oil content of compressed air max.	5 mg/m ³
Type	Poppet valve
Compressed air connection input	G 1/4
Compressed air connection output	G 1/4
Compressed air connection, exhaust	G 1/4
Electrical connection size	M12
Electrical connection number of poles	5-pin
Electrical connection coding	A-coded
Actual output value	0 ... 10 V
Nominal input value	0 ... 10 V
Pilot control exhaust	With collective pilot air exhaust
Industry	Industrial
Weight	0.26 kg

Material

Housing material	Polyamide
Seal material	Nitrile butadiene rubber
Material base plate	Aluminum
Part No.	R414008245

Technical information

The min. control pressure must be adhered to, since otherwise faulty switching and valve failure may result!

The pressure dew point must be at least 15 °C less than ambient and medium temperature and may not exceed 3 °C.

The oil content of compressed air must remain constant during the life cycle.

Use only the approved oils from AVENTICS. Further information can be found in the "Technical information" document (available in <https://www.emerson.com/en-us/support>).

Dimensions

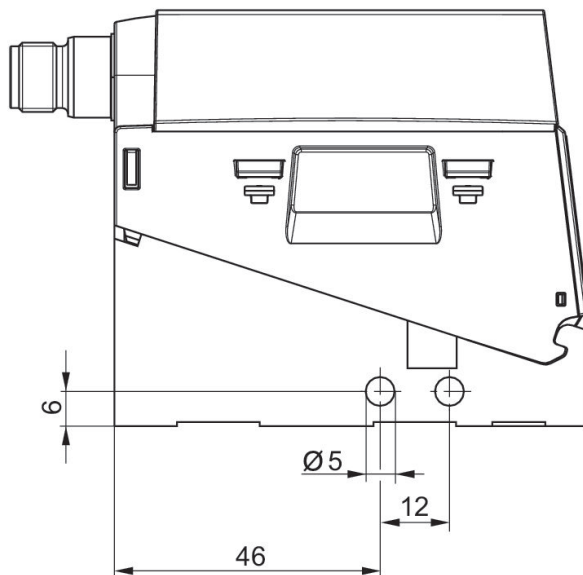

- 1) Port for plug M12x1
- 2) LED status display

Flow characteristic curve

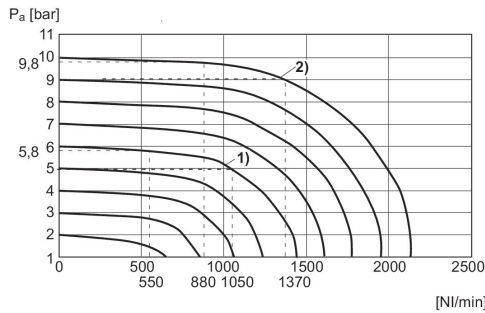

- 1) $P_v = [[7] \text{ bar}]$
- 2) $P_v = [[11] \text{ bar}]$
- P_v = Supply pressure
- P_a = Working pressure
- $P_v = P_a + 1$

Characteristic and pin assignment for potentiometer control without actual output value

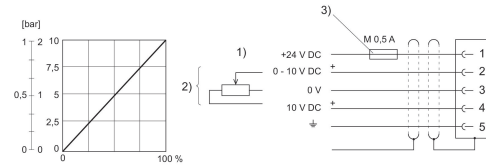

- 1) Supply voltage 2) Potentiometer supply (pin 4) and nominal value (pin 2) are related to 0 V. Potentiometer resistance min. 0-2 k Ω , max. 0-10 k Ω .
- 3) The operating voltage must be protected by an external M 0.5 A fuse. Connect the plug via a shielded cable to ensure EMC.

Characteristic and pin assignment for current control with actual output value

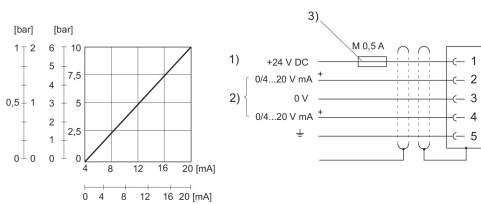

- 1) power supply
- 2) Actual value (pin 4) and nominal value (pin 2) are related to 0 V (pin 3). Nominal input value (ohmic load 100 Ω), actual output value: external ohmic load < 300 Ω . If the power supply is switched off, the nominal input value is high-ohmic.
- 3) The power supply must be protected by an external M 0.5 A fuse. Connect the plug via a shielded cable to ensure EMC.

Characteristic and pin assignment for current and voltage control with actual output value

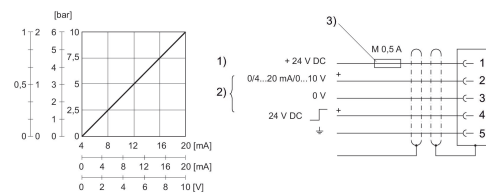

- 1) Operational voltage
- 2) Nominal value (pin 2) and switch output (pin 4) are related to 0 V. Acknowledge signal
- 3) The operating voltage must be protected by an external M 0.5 A fuse.

Characteristic and pin assignment for voltage control with actual output value

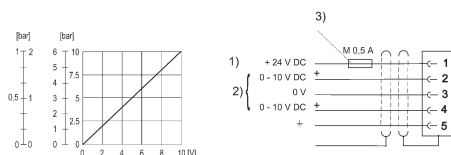

- 1) power supply
- 2) Actual value (pin 4) and nominal value (pin 2) are related to 0 V (pin 3). Nominal input value ($R = 1 \text{ M}\Omega$), actual output value: min. load resistance > 10 K Ω . If the power supply is switched off, the nominal input value is high-ohmic.
- 3) The power supply must be protected by an external M 0.5 A fuse. Connect the plug via a shielded cable to ensure EMC.