

Charnela trasera AB3, Serie CM1

R412027807

Charnela
trasera

2024-03-26

Fijación de horquilla AVENTICS

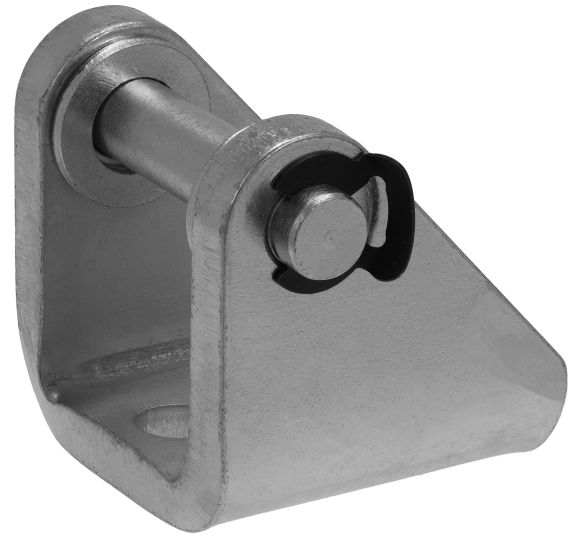

Datos técnicos

Sector

Industria

Versión

Versión: tipo ISO

Para serie

RPC

Diámetro de émbolo

50 mm

Material

Material

acero galvanizado

Nº de material

R412027807

Charnela trasera AB3, Serie CM1

R412027807

Charnela
trasera

2024-03-26

Dimensiones

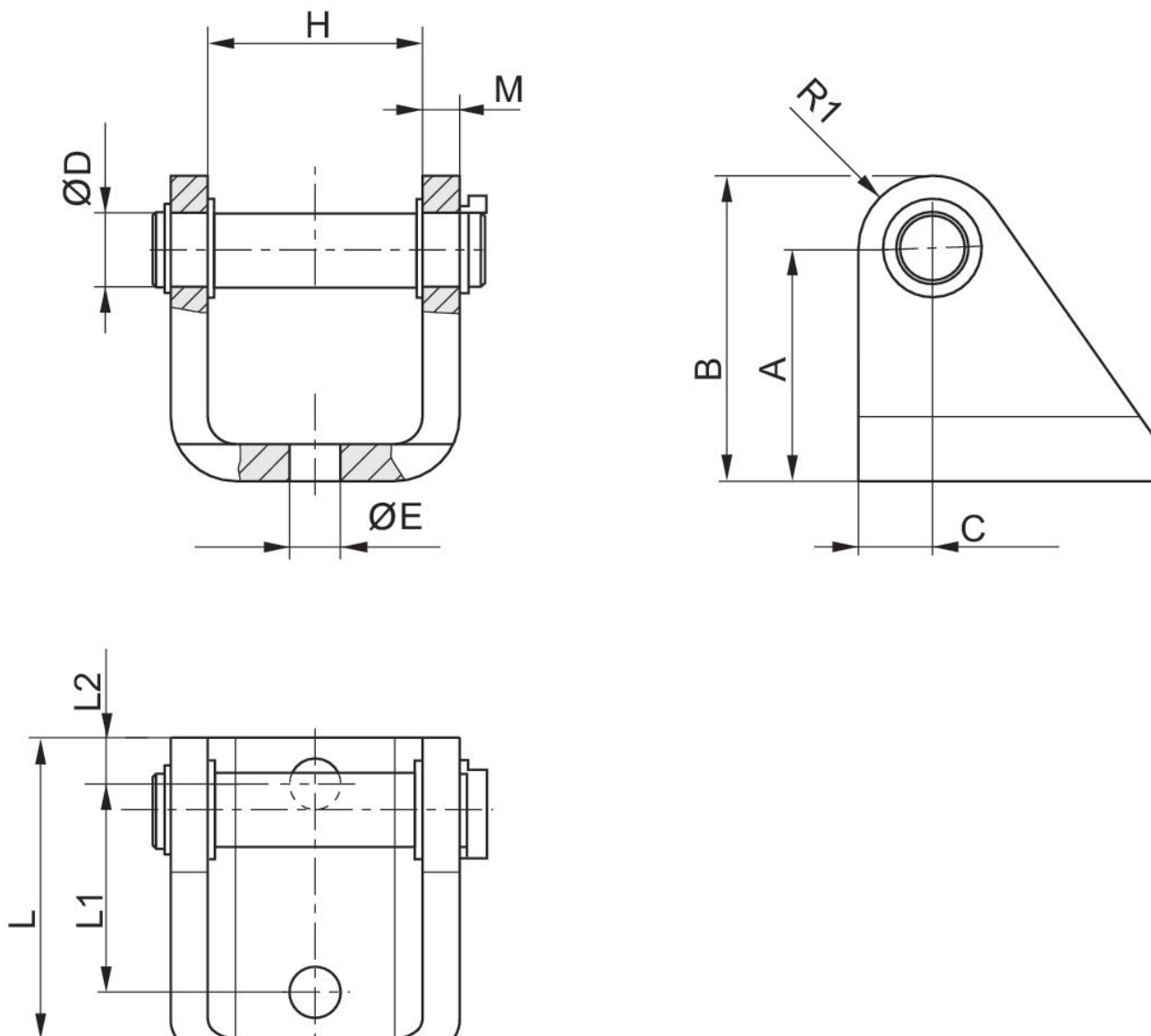

Ø del émbolo	N° de material	A	B	C	Ø D	Ø E	H	M	L
32	R412027805	32	44	12	10	9	30.2	5	55
40	R412027806	36	49	13	12	9	33.2	5	55
50	R412027807	45	58	13	12	11	37.2	8	55
63	R412027808	50	66	16	16	11	46.4	8	65

Ø del émbolo	L1	L2	R1
32	35	10	12
40	35	10	13
50	35	10	13
63	45	10	16