

AVENTICS Gabelbefestigungen



Technische Daten

Branche

Industrie

Version

Ausführung: ISO-Bauart

Für Serie

RPC

geeigneter Kolbendurchmesser

50 mm

Werkstoff

Werkstoff

Stahl verzinkt

Materialnummer

R412027807

Abmessungen

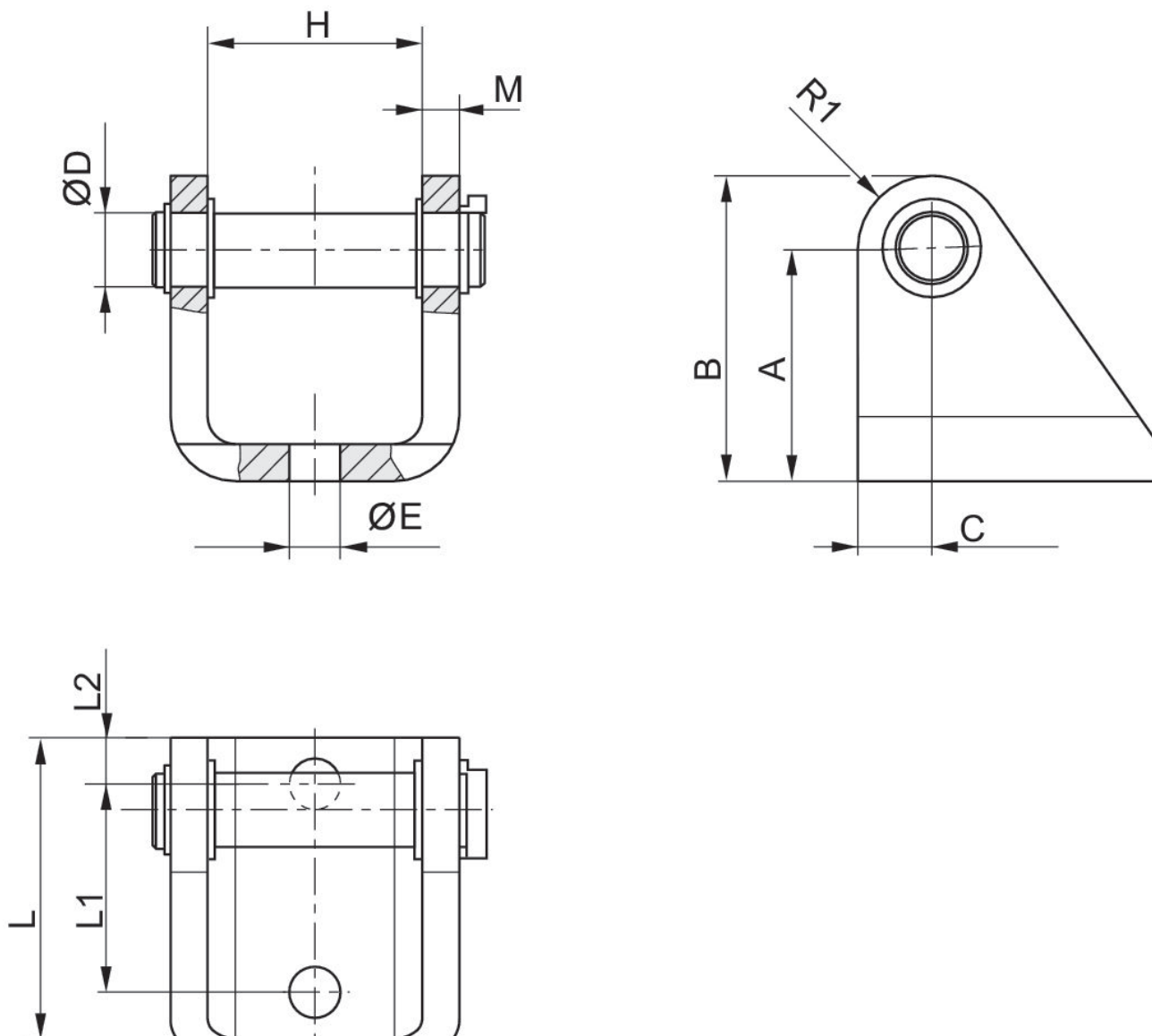

Kolben-Ø	Material-nummer	A	B	C	Ø D	Ø E	H	M	L
32	R412027805	32	44	12	10	9	30.2	5	55
40	R412027806	36	49	13	12	9	33.2	5	55
50	R412027807	45	58	13	12	11	37.2	8	55
63	R412027808	50	66	16	16	11	46.4	8	65

Kolben-Ø	L1	L2	R1
32	35	10	12
40	35	10	13
50	35	10	13
63	45	10	16