

Round plug connectors with cable, Series CON-RD

CON-RD

2023-12-05

R412026782

- Round plug connectors with connected cable
- M8x1, M12x1, M23, 7/8"
- Y cable

AVENTICS Series CON-RD Round plug connectors with cable

The AVENTICS Series CON-RD-with cable offers cables with round plug connectors for various types like M8x1, M12x1 or 7/8-16UNC and different cable length, optimized for our focused valves with M8x1 or M12x1 connection and electronic systems like AES and G3.

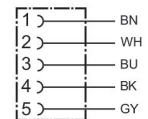

Technical data

Industry	Industrial
Type	Round plug connectors
Operational voltage	48 V AC/DC
Max. operating voltage AC	48 V DC
Max. operating voltage DC	48 V AC
Electrical connection 1, type	Socket
Electrical connection 1, thread size	M12x1
Electrical connection 1, number of poles	5-pin
Electrical connection 1, coding	A-coded
Cable exit 1	straight
Electrical connection 2, type	open cable ends
Shielding	shielded
Cable length	3 m
suitable for dynamic laying	suitable for dynamic laying
Min. bending radius	56 mm
Certificates	RoHS UL (Underwriters Laboratories)
Protection class	IP65 IP67 IP68

Round plug connectors with cable, Series CON-RD

CON-RD

2023-12-05

R412026782

Min. ambient temperature -30 °C

Max. ambient temperature 90 °C

Connector standard EN 61076-2-101

Max. current 4 A

Wire cross-section 0.34 mm²

Cable-Ø 5.6 mm

Delivery unit 1 piece

Material

Housing material Thermoplastic polyurethane (TPU)

Seal material Fluorocautchouc

Material cable sheath Polyurethane

Part No. R412026782

Technical information

The specified protection class is only valid in assembled and tested state.

Dimensions in mm

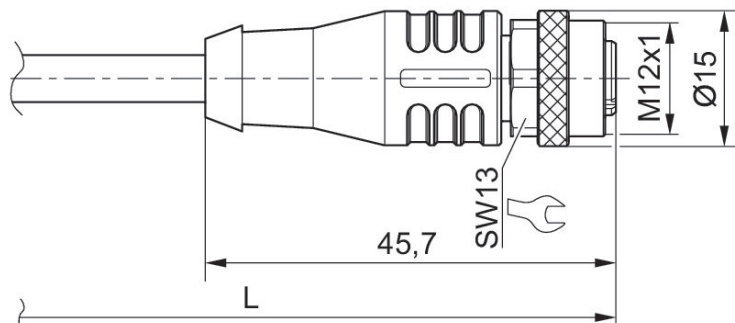

L = cable length

Round plug connectors with cable, Series CON-RD

CON-RD
2023-12-05

R412026782
Pin assignment, socket

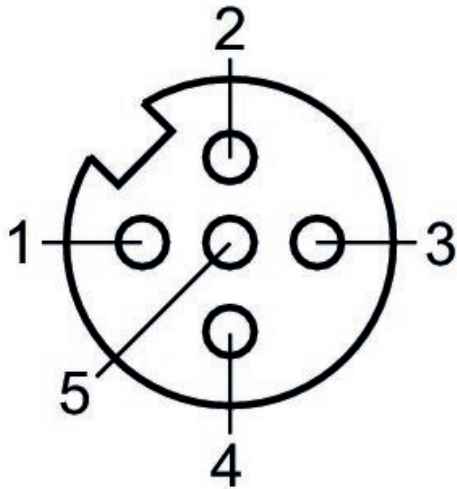

(1) BN=brown (2) WH=white (3) BU=blue (4) BK=black (5) GY=grey