

# Series UPG

## R412026310

### General series information AVENTICS Series UPG Grippers

- The AVENTICS Series UPG is a 2-finger parallel gripper characterized by its high gripping forces, precision, and exact movement of the clamping jaws. They can be selected based on the application requirements and flexibly equipped with object-specific gripper fingers.



### Technical data

Industry	Industrial
Number of fingers	2
Type	Parallel
Grippers type	2-finger, parallel gripper
Grippers function	double-acting, closed without pressure
Type	UPG-P-64-NC
Working pressure min.	4 bar
Working pressure max	6.5 bar
Min. ambient temperature	5 °C
Max. ambient temperature	90 °C
Magnetic piston	with magnetic piston
Max. particle size	5 µm
Pressure for determining forces	6 bar
Medium	Compressed air
Oil content of compressed air min.	0 mg/m <sup>3</sup>

Oil content of compressed air max.	5 mg/m <sup>3</sup>
Effective gripping force of O.D gripper per finger, min.	170 N
Effective total gripping force O.D. gripper, min.	340 N
Gripping force secured by spring max.	90 N
Max. permissible finger length	72 mm
Max. permissible finger mass	0.35 kg
Closing time at 6 bar	0.02 s
Opening time at 6 bar	0.04 s
Air consumption per double-stroke at 1 bar	17 cm <sup>3</sup>
Recommended workpiece mass	1.25 kg
Stroke per finger	6 mm
Closing/opening time only with spring	0.08 s

## Material

Housing material	Aluminum
Surface housing	anodized
Seal material	Acrylonitrile butadiene rubber
Material function parts	Steel, chrome-plated
Weight	0.37 kg
Part No.	R412026310

## Technical information

Grip tolerance determined by measuring the dispersion of the end positions for 100 successive strokes.

The pressure dew point must be at least 15 °C less than ambient and medium temperature and may not exceed 3 °C.

The oil content of compressed air must remain constant during the life cycle.

Use only the approved oils from AVENTICS. Further information can be found in the “Technical information” document (available in <https://www.emerson.com/en-us/support>).

## Dimensions

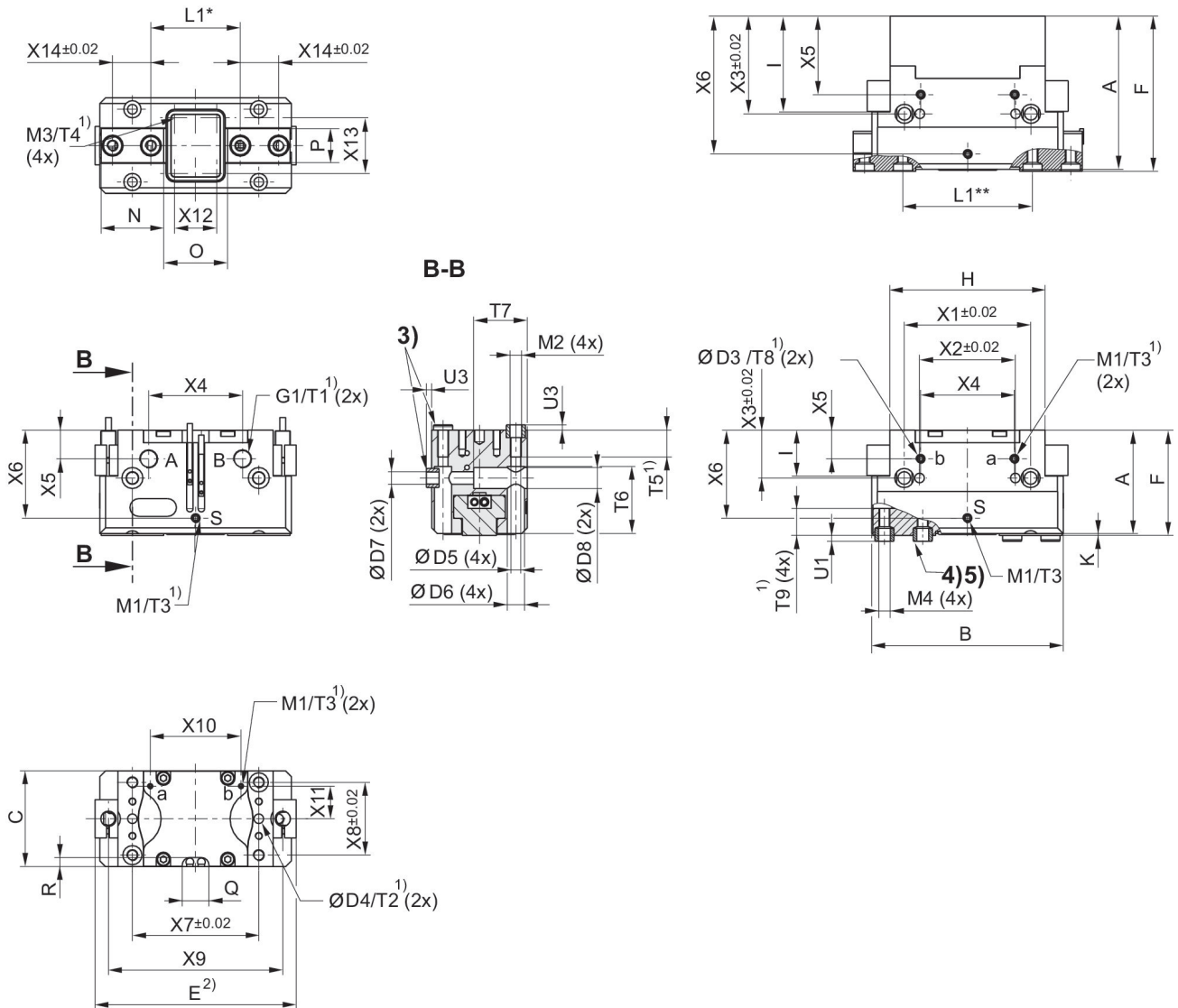

\* Gripper closed

\*\* Gripper open

1) min.

2) max.

3) Sleeve  $\varnothing D2$  h6  $\varnothing D2$  in housing for bottom gripper connection (2x)

4) Sleeve  $\varnothing D1$  h6  $\varnothing D1$  H7 in base jaw for bottom finger connection (4x)

5) Sleeve  $\varnothing D1$  h6  $\varnothing D1$  in base jaw for bottom finger connection (4x)

Part No.	A	B	C	D1 H7	D2 H7	D3 H7	D4 H7	D5	D6
R412026308	33,05	45	24	4	5	-	-	2.5	4.8
R412026309	46	57	30	5	6	-	-	3,3	5,8
R412026310	56	64	36	6	8	4	4	4,2	7,25
R412026311	66	80	42	8	8	-	4	4,2	7,25
R412026312	80	100	50	10	10	5	5	5,1	9
R412026313	92	125	60	10	12	6	6	6,8	10,5
R412026314	116	160	72	14	12	6	6	6,8	10,5

Part No.	D7	D8	E	F	G1	H	I	K	L1*
R412026308	2,6	4,8	-	33,75	M3	38	18,1	0,7	26,5
R412026309	3,3	5,8	-	47	M5	42	29	1	33,5
R412026310	4,2	7,25	70	57	M5	52	33	1	40,5
R412026311	5,1	9	87	67	M5	63	38	1	53
R412026312	6,6	11	105	81	G1/8	81	50	1	67
R412026313	9	14	130	93	G1/8	100	56	1	87
R412026314	9	14	162,5	117	G1/8	125	72	1	109

Part No.	L1**	M1	M2	M3	M4	N	O	P	Q
R412026308	21,5	M2	M3	M2	M2,6	14,8	14,9	6,8	-
R412026309	25,5	M5	M4	M2,5	M3	18,6	19	10	-
R412026310	28,5	M5	M5	M2,5	M4	21	20,3	12	-
R412026311	37	M5	M5	M2,5	M5	26	26,8	14,4	-
R412026312	47	M5	M6	M3	M6	32,7	33,3	17,8	-
R412026313	61	M5	M8	M3	M6	39	45,5	19,7	-
R412026314	77	M5	M8	M3	M10	50	57,9	26	11

Part No.	R	T1	T2	T3	T4	T5	T6	T7	T8
R412026308	-	4	-	4	3,5	8	16	14	-
R412026309	-	4,5	-	6	3,5	11	19	18	-
R412026310	-	6	6	6	3,5	12	24,1	25	5
R412026311	-	6	8	4	3,5	15	33	24	-
R412026312	-	7	6	6	5,5	14	35	28	5
R412026313	-	7	10	6	5,5	20	39,5	38	6
R412026314	5,1	7	12	6	5,5	20	55,5	41	7

Part No.	T9	U1	U3	X1	X2	X3	X4	X5	X6
R412026308	7,1	2,2	2	32	-	20,1	22	17,1	27,7
R412026309	8,5	2,2	2,5	35	-	30,5	24	26	41,5
R412026310	10	2,6	2,5	42	20	35,5	31	28	51
R412026311	10	2,6	2,5	52	-	38	40	30	57,5
R412026312	14,2	3,1	3	66	50	51	49	41	72
R412026313	13	3,1	3	82	60	60	63	45	83
R412026314	17	4	3	100	76	68	74	58	101

Part No.	X7	X8	X9	X10	X11	X12	X13	X14
R412026308	32	18	-	20	6,8	8	14	8
R412026309	35	22	-	22,6	8,7	11	18	12
R412026310	42	27	58,6	27	10	13	20,5	13
R412026311	52	32	73	37	12	17	14,4	16
R412026312	66	38	91	47,4	17	22	17,8	20
R412026313	82	45	116	61	20	35,5	19,7	24
R412026314	100	56	148,5	75	24,5	43	31	32

\* Gripper open

\*\* Gripper closed

## Max. permissible forces and torques on gripper

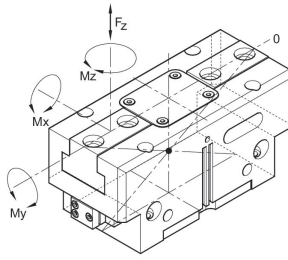

Moments and forces are static values, apply per base jaw, and may occur simultaneously. My may arise in addition to the moment generated by the gripping force itself.

## Maximum permissible projection Gripping range

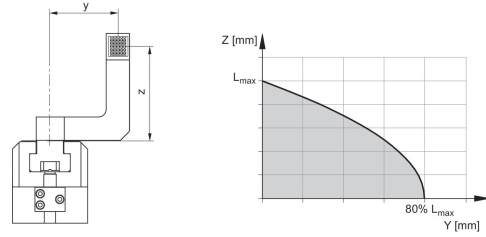

Lmax = Max. permissible finger length

## Tubeless direct connection M2

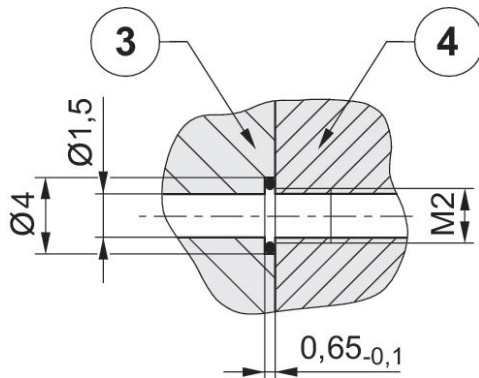

The direct connection is used for supplying compressed air without tubing, which is liable to faults. Instead, the pressure medium is fed through boreholes in the screw-on plate.

- 3) Adapter
- 4) Grippers

## Gripping force/finger UPG-P-160-NC

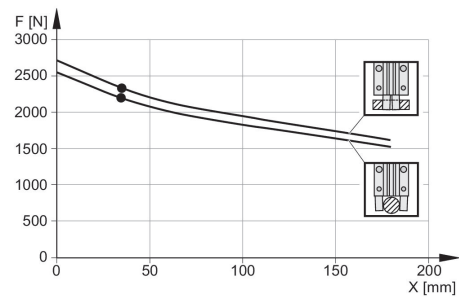

Gripping force/finger  
UPG-P-125-NC

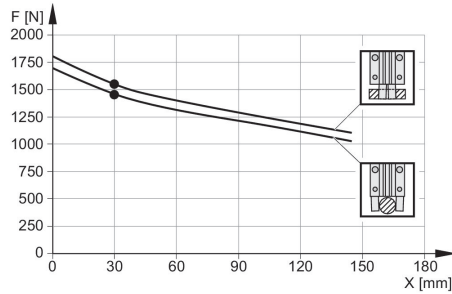

Gripping force/finger  
UPG-P-100-NC

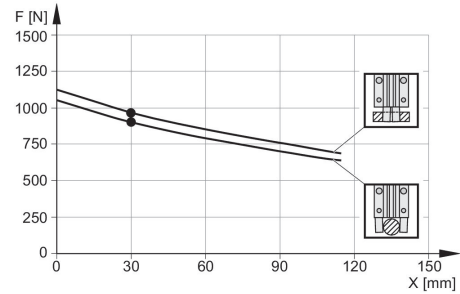

Gripping force/finger  
UPG-P-80-NC

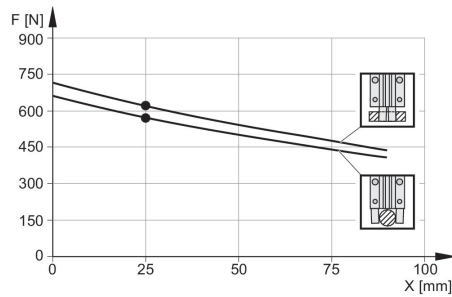

Gripping force/finger  
UPG-P-64-NC

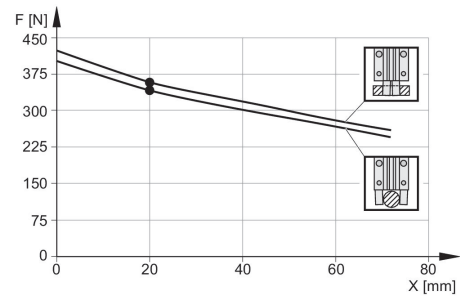

### Gripping force/finger UPG-P-50-NC

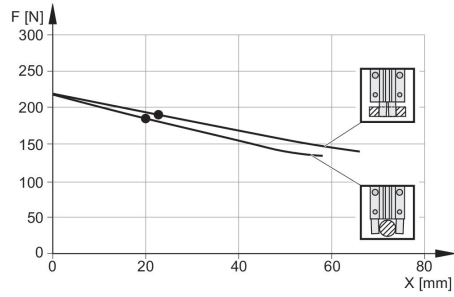

### Gripping force/finger UPG-P-40-NC

