

fijación de pivotes oscilantes MP2, Serie CM1

R412019991

Fijaciones
de pivote
oscilante

2023-10-26

Charnela de fijación AVENTICS

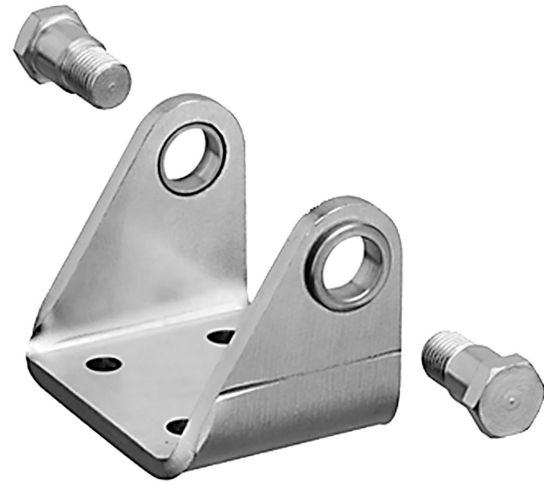

Datos técnicos

Sector

Industria

Para serie

RPC

Diámetro de émbolo

63 mm

Material

Material carcasa

Acero, cromado

Superficie Carcasa

galvanizado

Nº de material

R412019991

fijación de pivotes oscilantes MP2, Serie CM1

R412019991

Fijaciones
de pivote
oscilante

2023-10-26

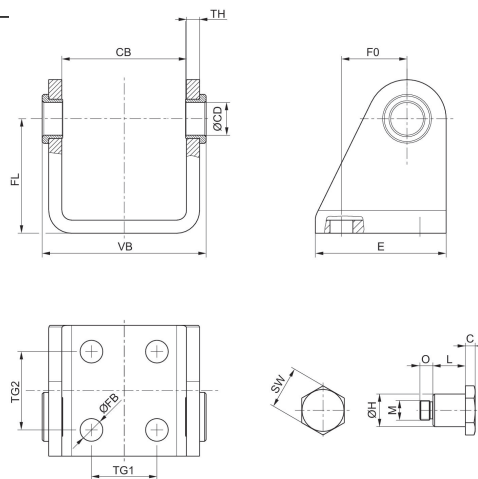

Ø del émbolo	Nº de material	C	CB	Ø CD H9	E	Ø FB	FL	F0	Ø H e9
32	R412019988	3	38.1	10	40	7	35	20	10
40	R412019989	3	46.1	12	50	9	40	27	12
50	R412019990	4	57.1	14	54	9	45	30	14
63	R412019991	4	70.1	16	65	9	50	34	16

Ø del émbolo	L	M	O	SW	TG1	TG2	TH	VB
32	9.9	M6x0,5	4	13	20	24	4	50.1
40	10.4	M6x0,5	4	17	28	30	5	60.1
50	12.9	M8x0,75	7	19	36	34	6	74.1
63	13.9	M8x0,75	7	19	42	35	6	87.1