

Trunnion mounting MP2, Series CM1

R412019991

Trunnion
mountings

2023-10-26

AVENTICS Trunnion mountings

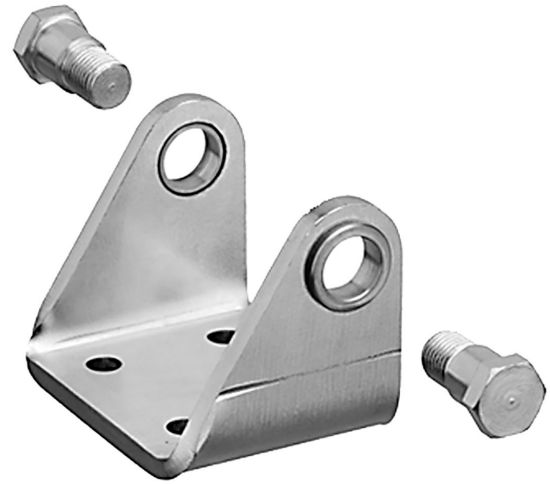

Technical data

Industry

Industrial

For series

RPC

Piston diameter

63 mm

Material

Housing material

Steel, chrome-plated

Surface housing

galvanized

Part No.

R412019991

Trunnion mounting MP2, Series CM1

R412019991

Trunnion
mountings

2023-10-26

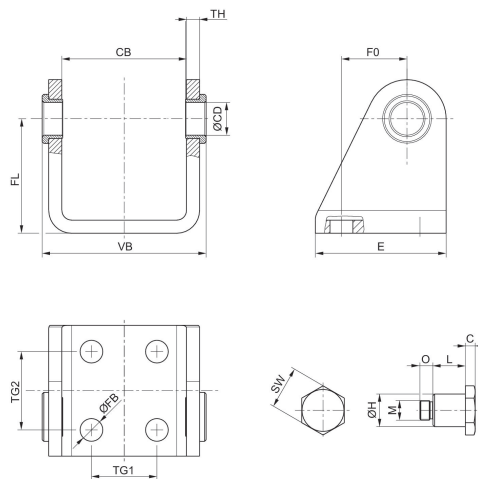

Piston Ø	Part No.	C	CB	Ø CD H9	E	Ø FB	FL	F0	Ø H e9
32	R412019988	3	38.1	10	40	7	35	20	10
40	R412019989	3	46.1	12	50	9	40	27	12
50	R412019990	4	57.1	14	54	9	45	30	14
63	R412019991	4	70.1	16	65	9	50	34	16

Piston Ø	L	M	O	SW	TG1	TG2	TH	VB
32	9.9	M6x0,5	4	13	20	24	4	50.1
40	10.4	M6x0,5	4	17	28	30	5	60.1
50	12.9	M8x0,75	7	19	36	34	6	74.1
63	13.9	M8x0,75	7	19	42	35	6	87.1