

AVENTICS Schwenkzapfenbefestigung

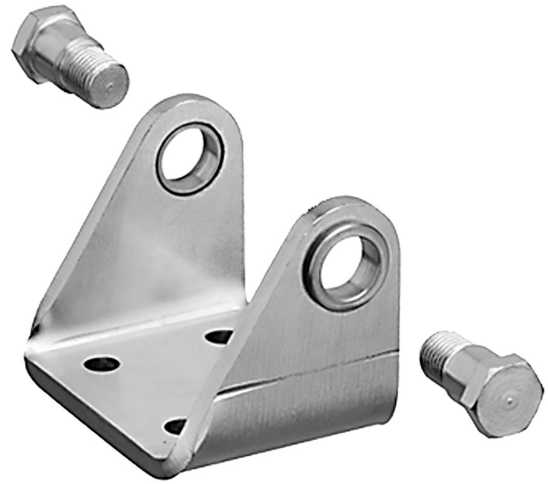

Technische Daten

Branche
Für Serie
geeigneter Kolbendurchmesser

Industrie
RPC
63 mm

Werkstoff

Werkstoff Gehäuse
Oberfläche Gehäuse
Materialnummer

Stahl, verchromt
verzinkt
R412019991

Schwenkzapfenbefestigung MP2, Serie CM1

R412019991

2023-10-26

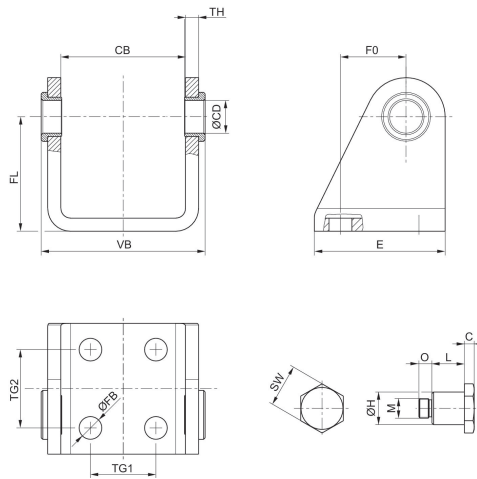

Kolben-Ø	Material-nummer	C	CB	Ø CD H9	E	Ø FB	FL	F0	Ø H e9
32	R412019988	3	38.1	10	40	7	35	20	10
40	R412019989	3	46.1	12	50	9	40	27	12
50	R412019990	4	57.1	14	54	9	45	30	14
63	R412019991	4	70.1	16	65	9	50	34	16

Kolben-Ø	L	M	O	SW	TG1	TG2	TH	VB
32	9.9	M6x0,5	4	13	20	24	4	50.1
40	10.4	M6x0,5	4	17	28	30	5	60.1
50	12.9	M8x0,75	7	19	36	34	6	74.1
63	13.9	M8x0,75	7	19	42	35	6	87.1