

Short-stroke cylinder, Series SSI

R412019802

General series information
AVENTICS Series SSI Short-stroke cylinders
(ISO 15524)

- The AVENTICS Series SSI are short stroke cylinders in accordance with the latest ISO standard 15524. The cylinders are compact and up to 30% lighter than comparable cylinders thanks to weight optimized profiles. In addition, they provide a high degree of flexibility in sensor assembly and extremely effective elastic cushioning.



Technical data

Industry	Industrial
Standards	ISO 15524
Piston Ø	12 mm
Stroke	15 mm
Ports	M5
Functional principle	Double-acting
Cushioning	Elastic cushioning
Magnetic piston	Piston with magnet
Environmental requirements	Industry standard
Piston rod	single
Scraper	Standard Industry Scraper
Pressure for determining piston forces	6,3 bar
Retracting piston force	53 N
Extracting piston force	71 N
Min. ambient temperature	-20 °C

Max. ambient temperature	80 °C
Working pressure min.	1 bar
Working pressure max	10 bar
Piston rod thread	M3
Impact energy	0.03 J
Weight 0 mm stroke	0.04 kg
Weight +10 mm stroke	0.012 kg
Stroke max.	75 mm
Medium	Compressed air
Min. medium temperature	-20 °C
Max. medium temperature	80 °C
Max. particle size	50 µm
Oil content of compressed air min.	0 mg/m ³
Oil content of compressed air max.	5 mg/m ³

Material

Piston rod	Stainless Steel
Scraper material	Nitrile butadiene rubber
Seal material	Nitrile butadiene rubber
Material, front cover	Brass
Cylinder tube	Aluminum
End cover	Aluminum
Part No.	R412019802

Technical information

Use our Internet configurator to order variants with an external thread.

The pressure dew point must be at least 15 °C less than ambient and medium temperature and may not exceed 3 °C.

The oil content of compressed air must remain constant during the life cycle.

Use only the approved oils from AVENTICS. Further information can be found in the “Technical information” document (available in <https://www.emerson.com/en-us/support>).

Dimensions

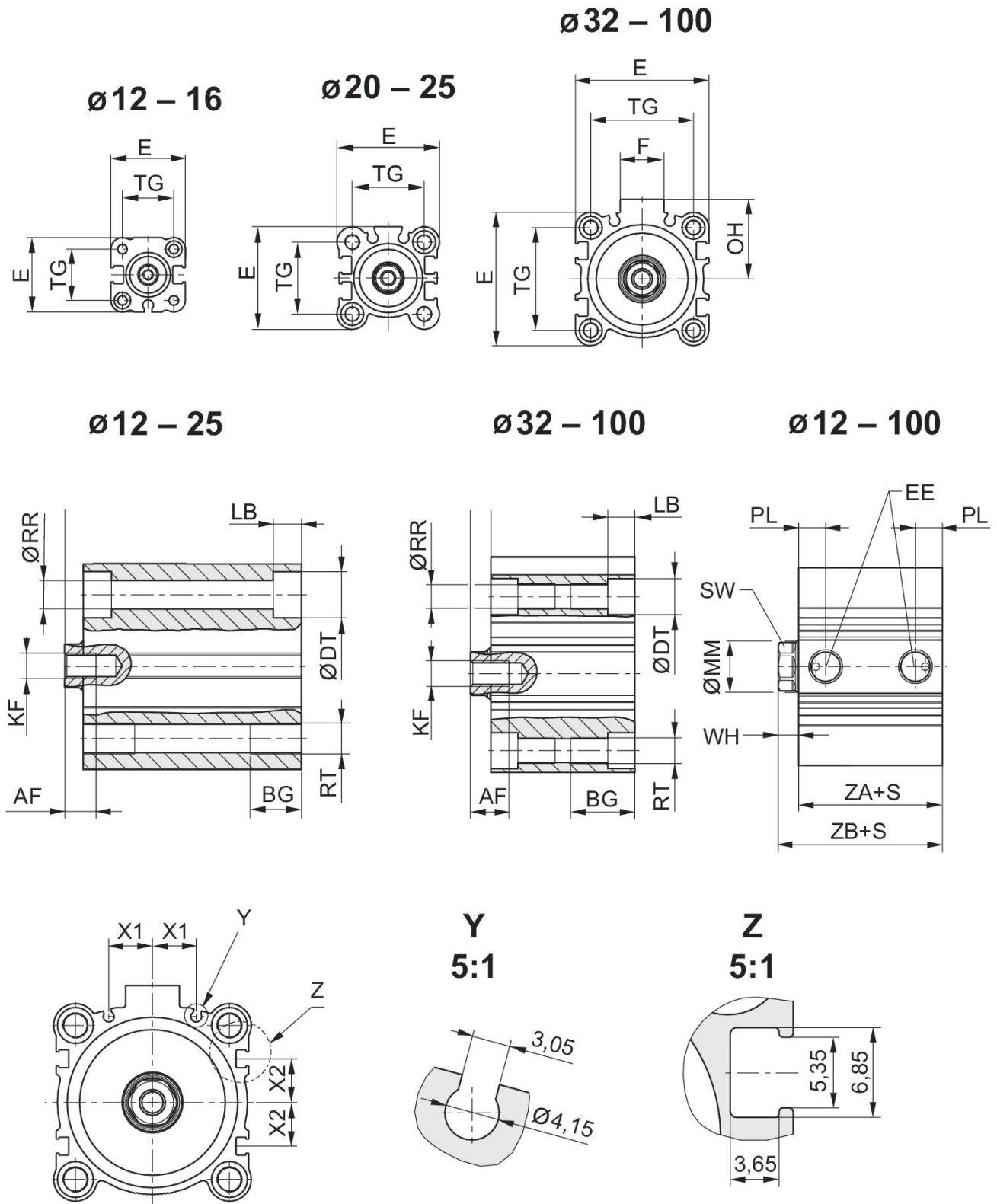

S = stroke

Piston Ø	AF	BG	ØDT	E	EE	F	KF	LB max.	ØMM f8
12	6	7	6.5	25	M5	-	M3	3.5	6
16	8	7	6.5	29	M5	-	M4	3.5	8
20	7	10	9	36	M5	-	M5	5.5	10
25	12	10	9	40	M5	-	M6	5.5	12
32	13	16	9	45	G 1/8	17	M8	5.5	16
40	13	16	9	52	G 1/8	17	M8	5.5	16
50	15	20	11	64	G 1/4	21	M10	8	20
63	15	25	14	77	G 1/4	21	M10	10.5	20
80	21	30	17.5	98	G 3/8	26	M16	13.5	25
100	27	30	17.5	117	G 3/8	26	M20	13.5	32

Piston Ø	OH	PL	ØRR	RT	SW	TG	WH	X1	X2
12	-	5.5	3.7	M4	5	15,5 ±0,3	3,5 ±1,5	0	0
16	-	5.5	3.7	M4	7	20 ±0,3	3,5 ±1,5	0	0
20	-	5.5	5.55	M6	8	25,5 ±0,3	4,5 ±1,5	5.7	4.3
25	-	5.5	5.55	M6	10	28 ±0,3	5 ±1,5	6	5
32	27	7.5	5.55	M6	13	34 ±0,3	7 ±2	8.5	7.5
40	31	7.5	5.55	M6	13	40 ±0,3	7 ±2	10.8	11
50	39	10.5	7.4	M8	17	50 ±0,5	8 ±2	14	13
63	45.5	10.5	9.3	M10	17	60 ±0,5	8 ±2	17	17
80	59	12.5	11.2	M12	22	77 ±0,5	10 ±2	23.5	21
100	65	14	11.2	M12	27	94 ±0,5	12 ±2,5	31	28

Piston Ø	ZA±0,2	ZB±2
12	28	31.5
16	30.5	34
20	31.5	36
25	32.5	37.5
32	33	40
40	39.5	46.5
50	40.5	48.5
63	46	54
80	53.5	63.5
100	63	75

Maximum admissible lateral force Ø 32 ... 100 mm

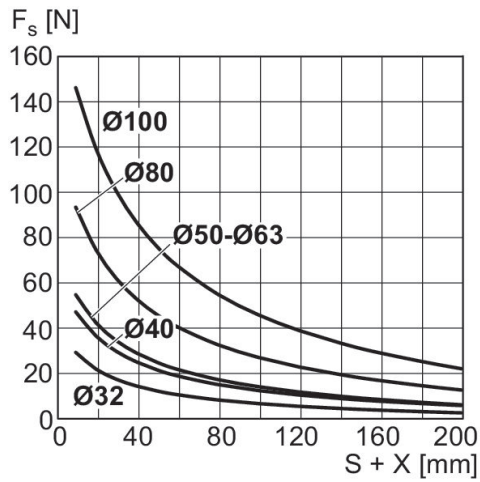

X = distance between force application point and cylinder cover
FS = lateral force
S = stroke

Maximum admissible lateral force Ø 12 ... 25 mm

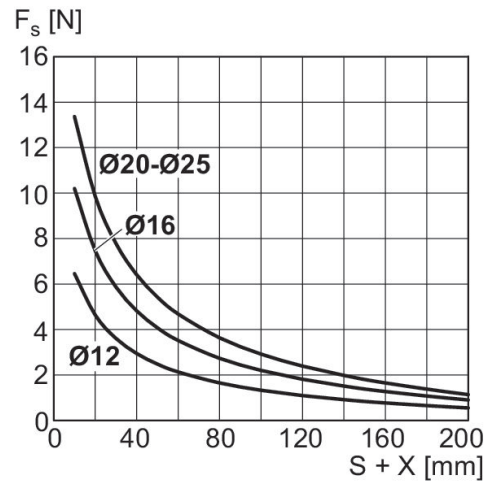

X = distance between force application point and cylinder cover
FS = lateral force
S = stroke

Maximum admissible lateral force Ø 12 ... 25 mm

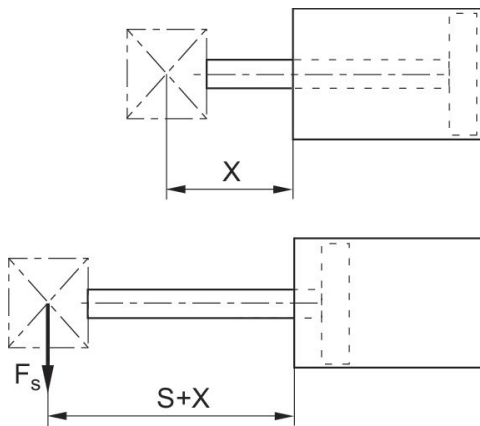

X = distance between force application point and cylinder cover
FS = lateral force
S = stroke

Overview drawing

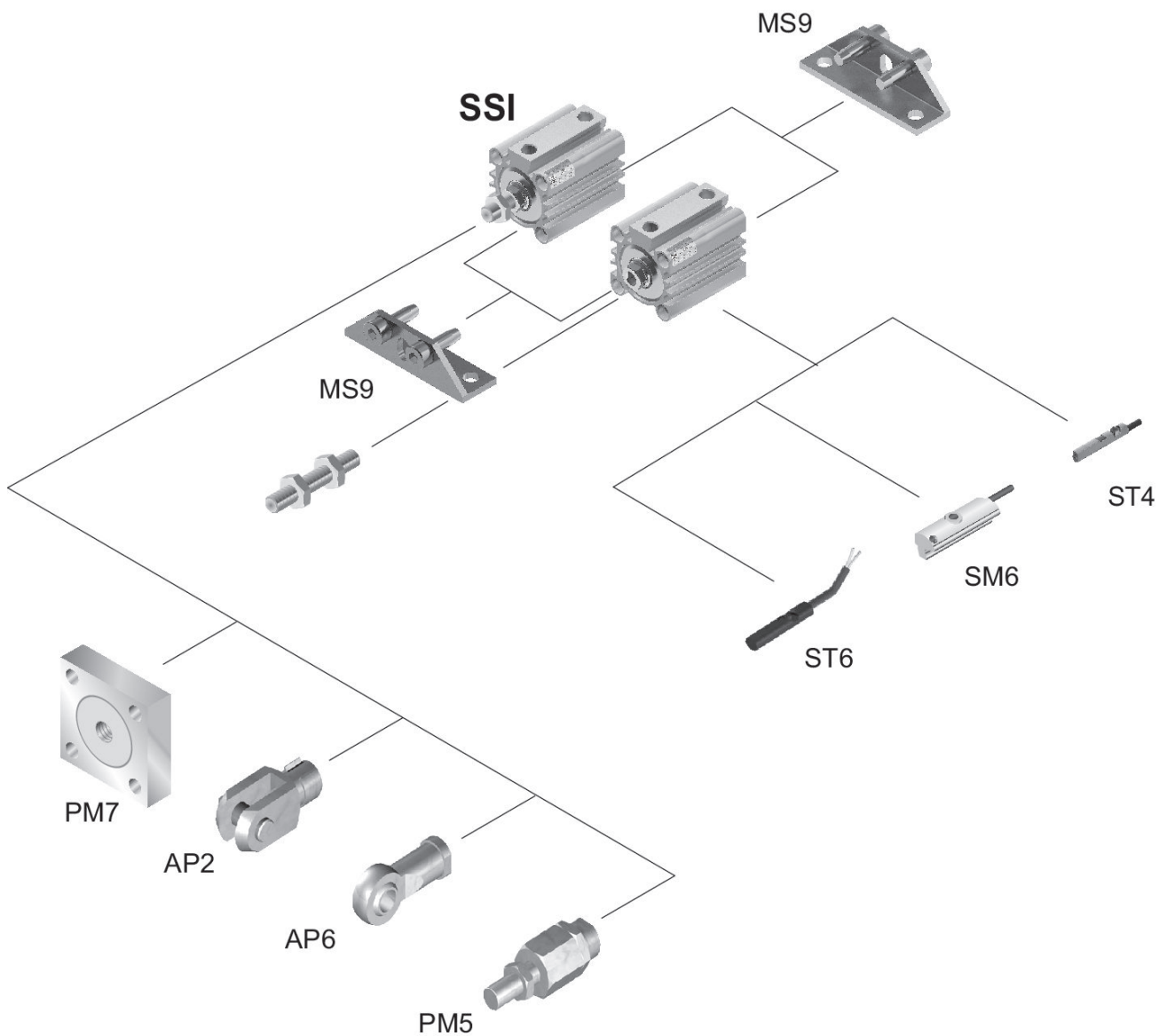

Use our Internet configurator to order variants with an external thread.

NOTE: This overview drawing is only for orientation to indicate where the various accessory parts can be fastened to the cylinder. The illustration has been simplified for this purpose. It is thus not possible to derive the dimensions from this overview.