

Blanking screw with O-ring, Series FPT

2024-03-21

R412010746

AVENTICS Blanking screws and connectors

Technical data

Industry	Industrial
Compressed air connection type	External thread
Port G	G 1/2
Type	FPT-S-RBA
Min. working pressure	0 bar
Max. working pressure	16 bar
Min. ambient temperature	-20 °C
Max. ambient temperature	80 °C
Delivery unit	25 piece

Material

Material	brass, nickel-plated
Seal material	Nitrile butadiene rubber
Part No.	R412010746

Dimensions

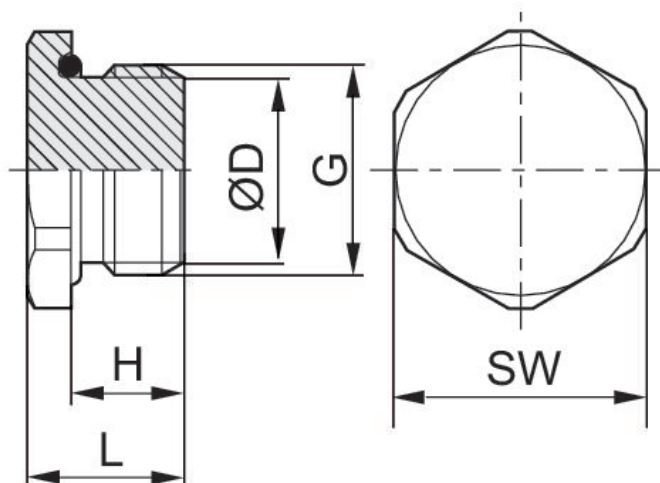

Blanking screw with O-ring, Series FPT

2024-03-21

R412010746

Part No.	Port G	ØD	H	L	SW
R412010743	G 1/8	8	5.5	8	14
R412010744	G 1/4	11	6.5	10	19
R412010745	G 3/8	14	7.5	11.5	22
R412010746	G 1/2	17.5	9	13	24