

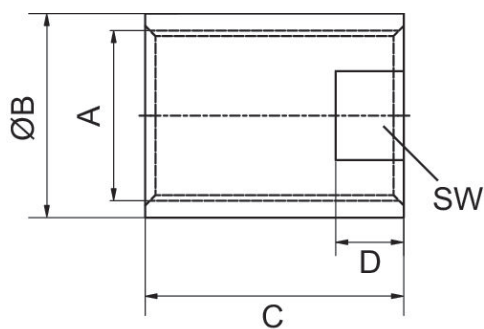

Données techniques

Secteur	Industrie
Fourniture	2 Pcs.
Poids	0.06 kg
Matériau boîtiers	Acier, chromé
Surface Boîtier	nitrocarburation en bain de sels
Référence	R412010339



Référence	A	ØB	C	D	SW
R412010335	M8x1	11	12	-	-
R412010336	M10x1	14	15	-	-

Douille de butée

2024-01-18

R412010339

Référence	A	ØB	C	D	SW
R412010337	M12x1	16	20	–	–
R412010338	M14x1,5	18	20	6	15
R412010339	M20x1,5	25	35	8	22
R412010340	M25x1,5	30	38	10	30
1820360039	M8x1	10	6	12	–
1820360040	M10x1	12,5	10	20	–
1820360041	M12x1	15	10	20	–
1820360042	M14x1,5	17	8	20	15
1820360043	M20x1,5	24,8	13	25	22
1820360044	M25x1,5	30	16	32	27