

AVENTICS Series NU2 Fittings with tube nuts

AVENTICS Series NU2, are a complete range of plastic and Brass fittings with tube nuts, Versatile and safe NU2 fittings with nuts benefit of a large selection of connection type.



Technical data

Industry	Industrial
Fitting type	Swivel banjo connection 1-fold
Compressed air connection type	External thread
Port G	G 3/8
Compressed air connection type 2	plug-in with tube nut
Port D	Ø 13
Type	NU2-S-RW1
Min. working pressure	-0.95 bar
Max. working pressure	10 bar
Min. ambient temperature	-10 °C
Max. ambient temperature	60 °C
Delivery unit	2 piece
Weight	0.079 kg

Material

Housing material	Aluminum
Surface housing	anodized
Seal material	Polyvinyl chloride
Part No.	R412007839

Dimensions

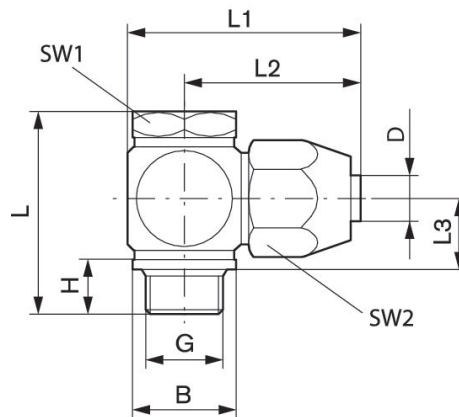

for fabric-reinforced plastic tubing

Part No.	Port D	Port G	B	H	L	L1	L2	L3	SW1
1823391293	Ø 4	G 1/8	14	10	32.5	34	26.5	13.7	14
1823391294	Ø 6	G 1/4	18	12.5	39	39.5	30	14.5	17
1823391295	Ø 8	G 1/4	18	12.5	42	42	32.5	16	17
1823391296	Ø 8	G 3/8	21	12.5	43	47	35	15.5	22
R412010658	Ø 9	G 1/4	18.9	7.9	40	42	32.5	15.6	17
R412007838	Ø 13	G 1/2	22.9	14	49.5	55	40	18.5	27
R412007839	Ø 13	G 3/8	22.9	12.5	47	49	37	18.5	22
1823391807	Ø 18	G 3/4	33	18.5	66	69	51	25	32
1823391808	Ø 18	G 1	40	20.5	70	77	55	25	41

Part No.	SW2
1823391293	17
1823391294	19
1823391295	22
1823391296	22
R412010658	24
R412007838	30
R412007839	30
1823391807	41
1823391808	41

Connection D = inside diameter of the tubing to be used