

Series AS3

Qn = 14500 l/min

Technical data

Industry	Industrial
Parts	Reservoir
Reservoir	reservoir, metal, with inspection glass
Filter reservoir volume	49 cm ³
inspection glass	with window
Min. working pressure	0 bar
Max. working pressure	16 bar
Min. ambient temperature	-10 °C
Max. ambient temperature	50 °C
Min. medium temperature	-10 °C
Max. medium temperature	50 °C
Medium	Compressed air
Weight	0.338 kg

Material

Material reservoir	Die cast zinc
Seal material	Acrylonitrile butadiene rubber
Part No.	R412007349

Technical information

The pressure dew point must be at least 15 °C less than ambient and medium temperature and may not exceed 3 °C.

The oil content of compressed air must remain constant during the life cycle.

Use only the approved oils from AVENTICS. Further information can be found in the "Technical information" document (available in <https://www.emerson.com/en-us/support>).

Reservoir, Series AS3-CLA

2024-03-20

R412007349

Dimensions in mm

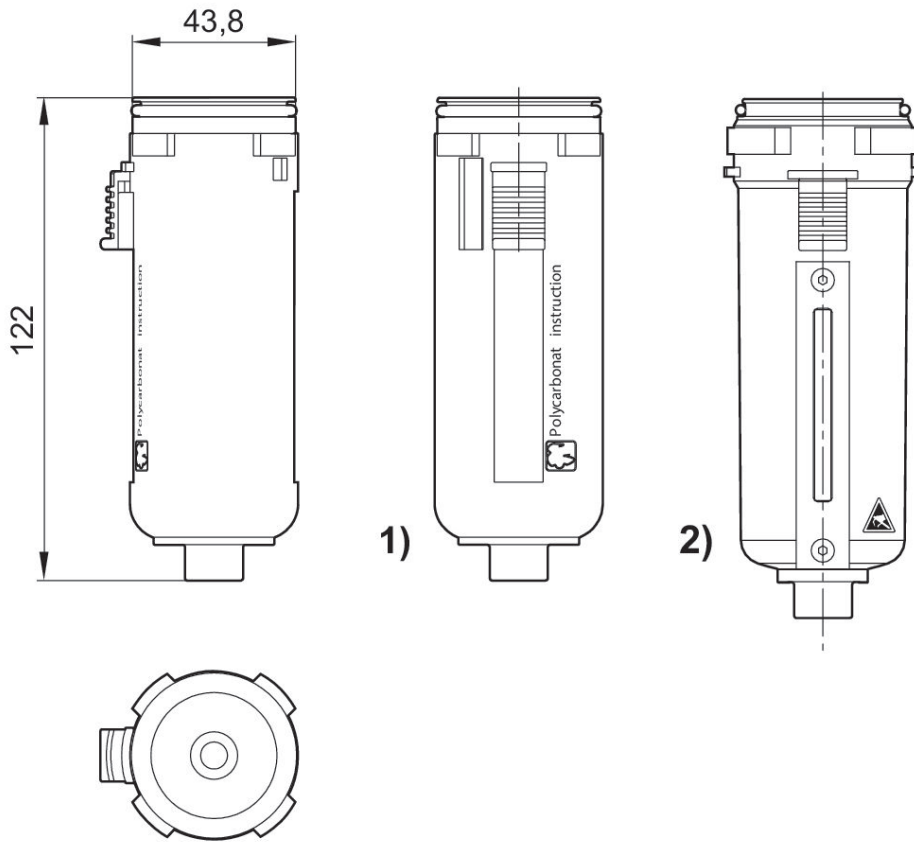

- 1) Plastic reservoir and protective guard with window
- 2) Metal reservoir with inspection glass