



Dados técnicos

Setor

Ø externo

Lote de fornecimento

Material de caixa

Nº de material

Indústria

7 mm

6 Peça

Aço inoxidável

R412000668

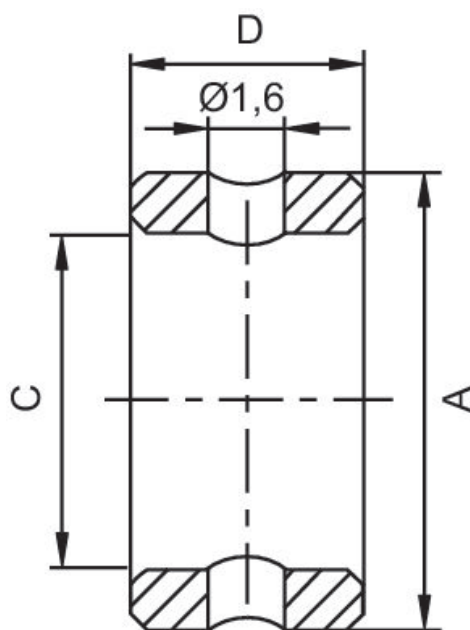

N° de material	Ø	A k6	B k6	C ±0,1	D -0,2	E +0,2
R412000669	5	5	-	3,4	3	-
R412000668	7	7	-	5,5	3	-
R412000670	9	9	-	6,6	4	-
R412000671	12	12	-	9,0	4	-
R402003731	16	16	-	11	6	-