

Zentrierringe

R412000668

2024-01-18



Technische Daten

Branche

Außen-Ø

Lieferumfang

Werkstoff Gehäuse

Materialnummer

Industrie

7 mm

6 Stück

Nichtrostender Stahl

R412000668

Zentrierringe

2024-01-18

R412000668

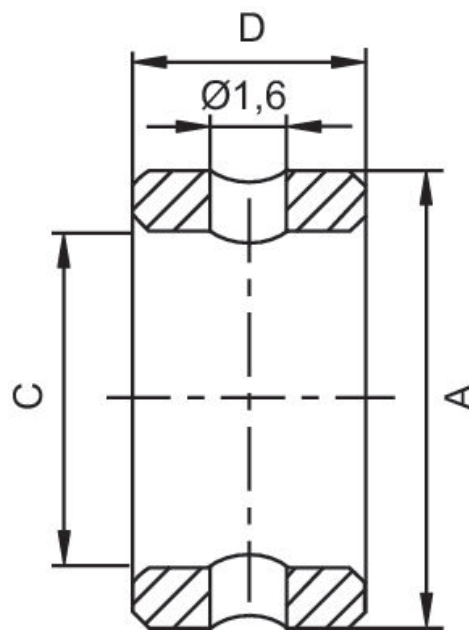

Material-nummer	Ø	A k6	B k6	C ±0,1	D -0,2	E +0,2
R412000669	5	5	-	3,4	3	-
R412000668	7	7	-	5,5	3	-
R412000670	9	9	-	6,6	4	-
R412000671	12	12	-	9,0	4	-
R402003731	16	16	-	11	6	-