

用于行程长度设置的缓冲器组件

2023-10-25

R402002806

底脚安装件



技术数据

行业

工业

结构特点

Ø 50 ... 63 mm

材料

物料号

R402002806

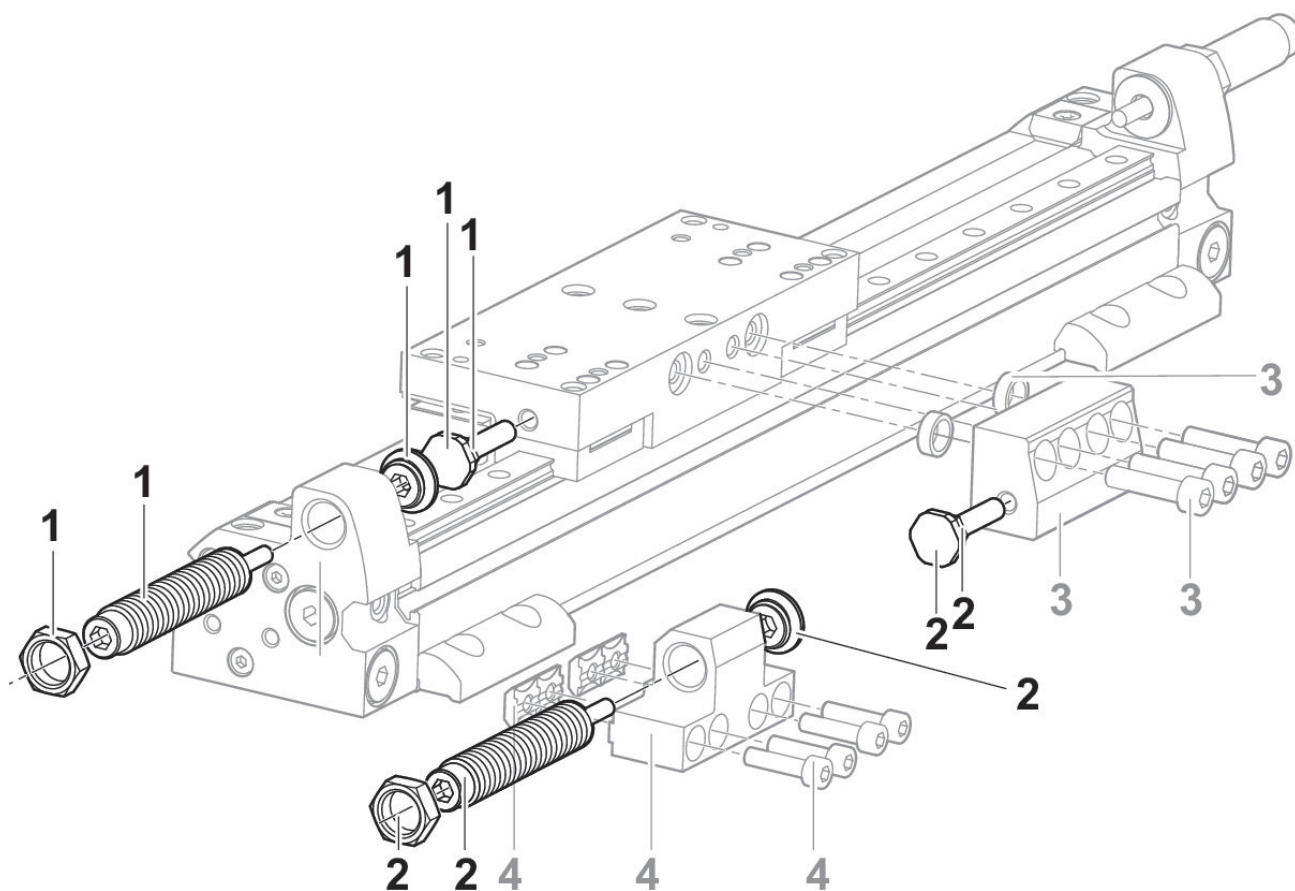

- 1) 缓冲器组件
- 2) 缓冲器组件
- 3) 冲击

4) 缓冲器支架

阻尼图
Ø 63 mm

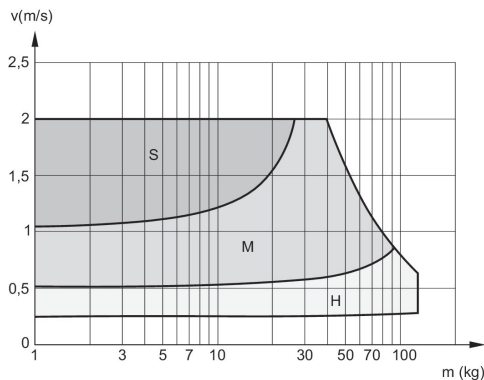

V = 速度 [m/s]
M = 移动质量
S = soft
M = medium
H = hard

阻尼图
Ø 50 mm

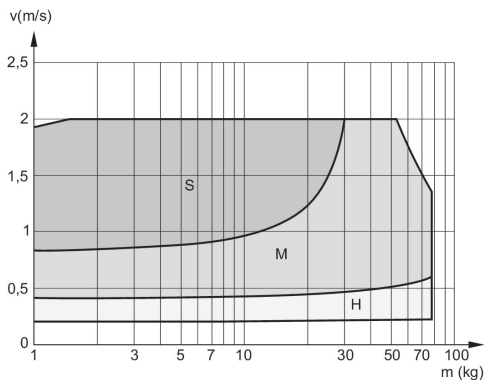

V = 速度 [m/s]
M = 移动质量
S = soft
M = medium
H = hard

阻尼图
Ø 40 mm

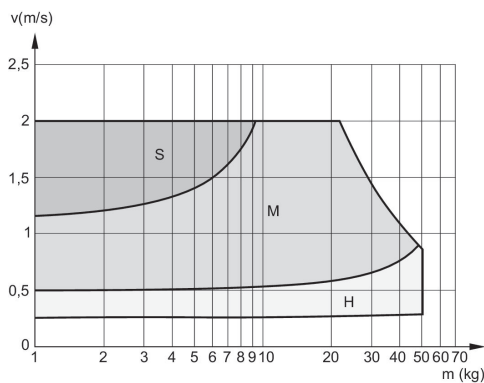

V = 速度 [m/s]
M = 移动质量
S = soft
M = medium
H = hard

阻尼图
Ø 32 mm

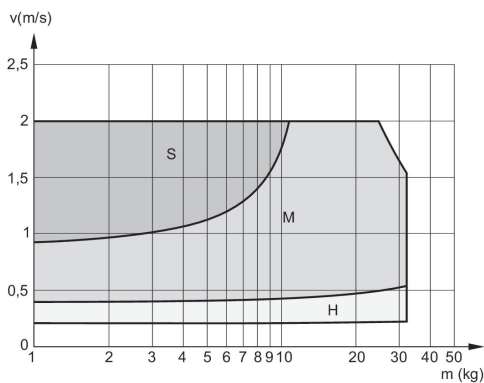

V = 速度 [m/s]
M = 移动质量
S = soft
M = medium
H = hard

R402002806

阻尼图
Ø 25 mm

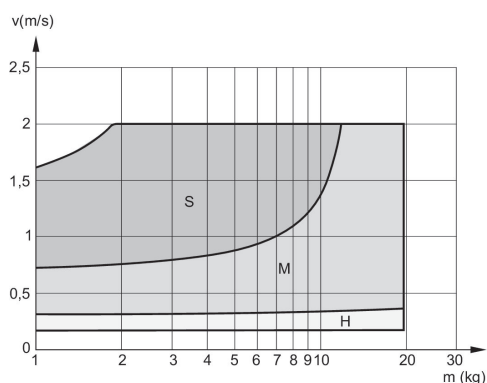

V = 速度 [m/s]
M = 移动质量
S = soft
M = medium
H = hard

阻尼图
Ø 16 mm

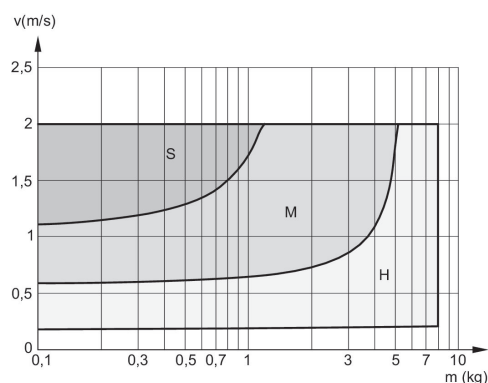

V = 速度 [m/s]
M = 移动质量
S = soft
M = medium
H = hard