

# 用于行程长度设置的缓冲器组件

2023-10-25

R402002805

---

底脚安装件



## 技术数据

行业

工业

结构特点

Ø 25 mm

Ø 32 mm

Ø 40

## 材料

物料号

R402002805

# 用于行程长度设置的缓冲器组件

2023-10-25

R402002805

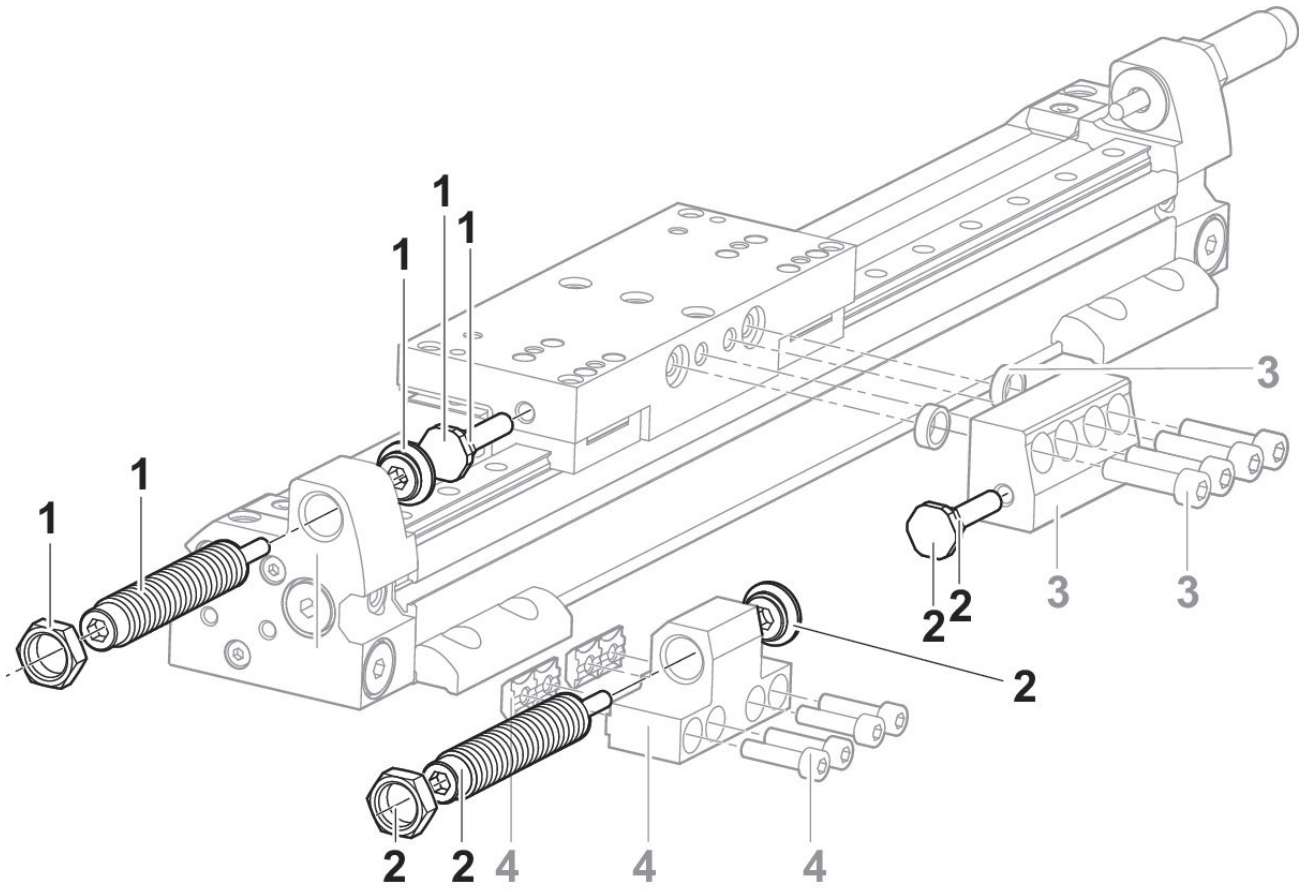

- 1) 缓冲器组件
- 2) 缓冲器组件
- 3) 冲击
- 4) 缓冲器支架

阻尼图  
Ø 63 mm

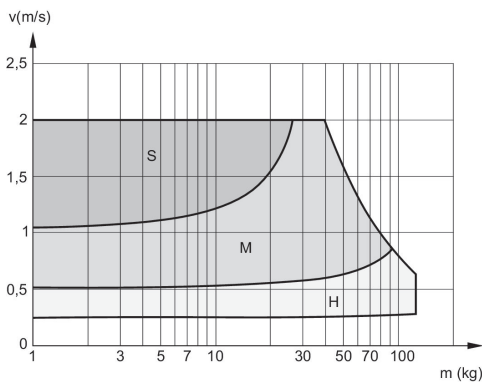

V = 速度 [m/s]  
M = 移动质量  
S = soft  
M = medium  
H = hard

阻尼图  
Ø 50 mm

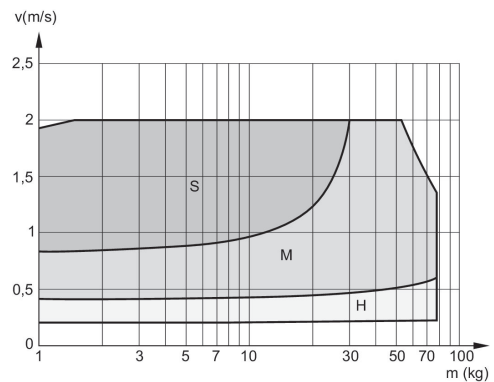

V = 速度 [m/s]  
M = 移动质量  
S = soft  
M = medium  
H = hard

R402002805

## 阻尼图

Ø 40 mm

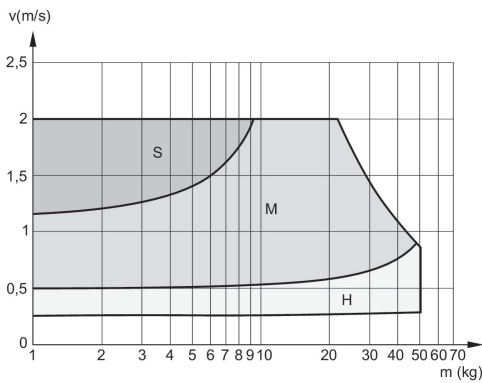

V = 速度 [m/s]  
M = 移动质量  
S = soft  
M = medium  
H = hard

## 阻尼图

Ø 32 mm

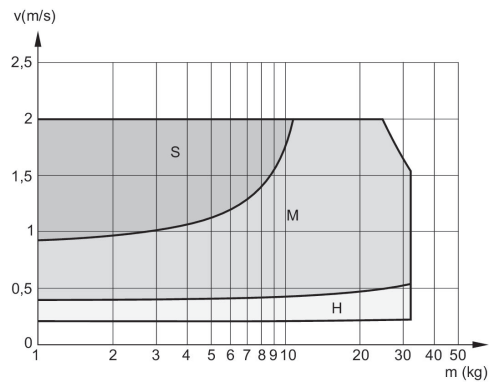

V = 速度 [m/s]  
M = 移动质量  
S = soft  
M = medium  
H = hard

## 阻尼图

Ø 25 mm

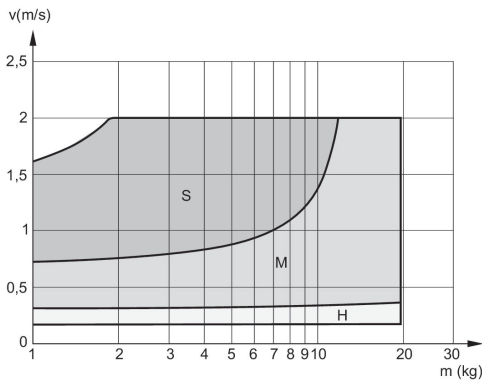

V = 速度 [m/s]  
M = 移动质量  
S = soft  
M = medium  
H = hard

## 阻尼图

Ø 16 mm

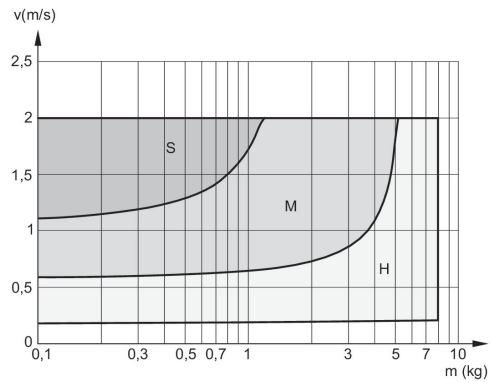

V = 速度 [m/s]  
M = 移动质量  
S = soft  
M = medium  
H = hard