

Kit for stroke length adjustment

2024-01-18

R402000136

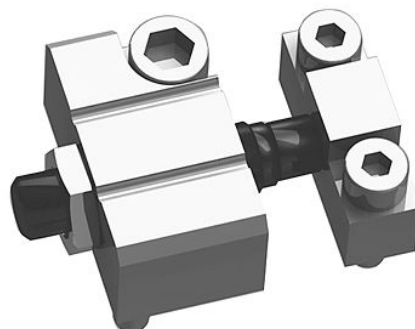

Technical data

Industry

Industrial

Piston Ø

20 mm

Type

Shock absorber 0821005013 included in scope of delivery

Part No.

R402000136

Kit for stroke length adjustment

2024-01-18

R402000136

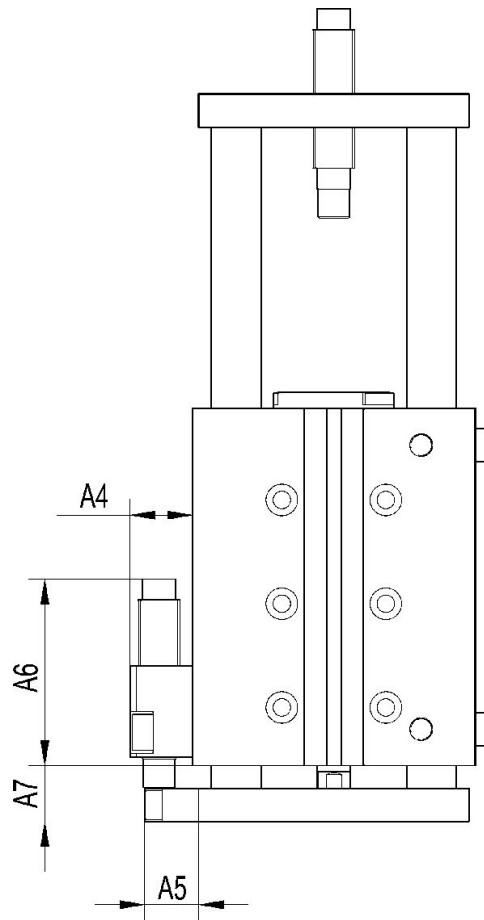

Part No.	Ø	A4	A5	A6 min.	A6 max.	A7 min.	A7 max.	L 1)
R402000134	12	13	13	21	29	13	25	12
R402000135	16	15	13	24	45	13.5	43.5	30
R402000136	20	15	13	26	44	15.5	45.5	30

1) Adjustment length L = A7 max. ... A7 min.