

AVENTICS Series Easy-2-Combine Interface

The AVENTICS Easy-2-Combine standardized mounting interface with interlocking connections make it possible to combine the mini slide, rodless cylinders and rotary modules into multi-axis systems without additional connection plates. This simplifies machine design and construction and saves time and money.

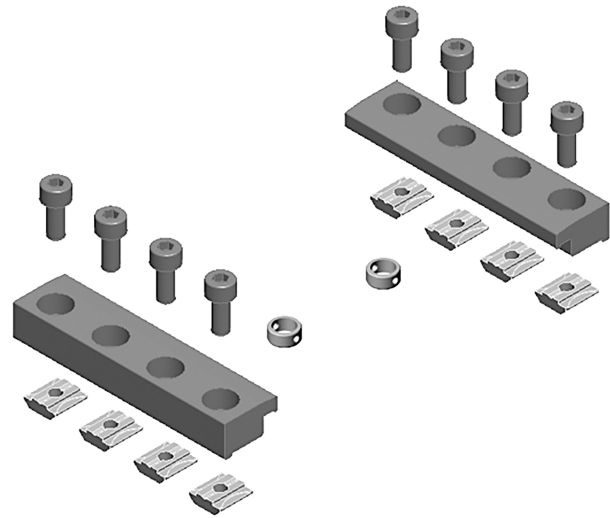

Technical data

Industry

Industrial

For series

CKP

CKP

Easy2Combine basic

CKP-32

Easy2Combine add-on part

CKP-32

Weight

0.4 kg

Material

Material centering rings

Stainless Steel

Material centering sleeve

Stainless Steel

Connection plate material

Aluminum

Material clamping fixtures

Aluminum

Screws material

Steel, chrome-plated

Material T-groove nut

Steel, chrome-plated

Part No.

R039120048

Easy2Combine, Connection kit

R039120048

Easy2Combine

2024-01-17

Y-axis connected by the profile (carriage travels)

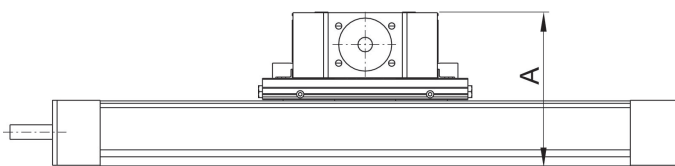
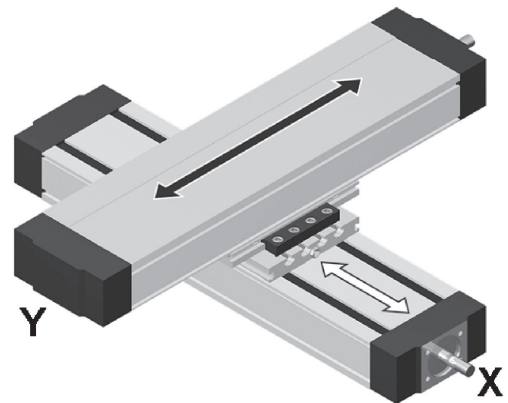
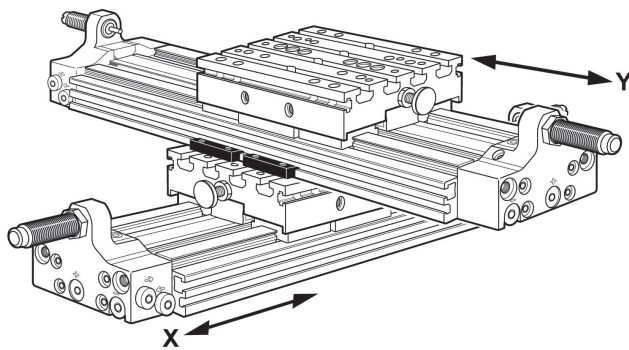

Part No.	X 1)	Y 2)	A
R039120045	CKP-16 CKP-25	CKP-16	96 106
R039120046	CKP-25	CKP-25	116
R039120047	CKP-32	CKP-25	135
R039120048	CKP-32	CKP-32	150

1) basic
2) add-on-part
m = mass