

Racor recto, 1/8" BSP

K599AU571903185

2025-01-06

Accesorios mecánicos

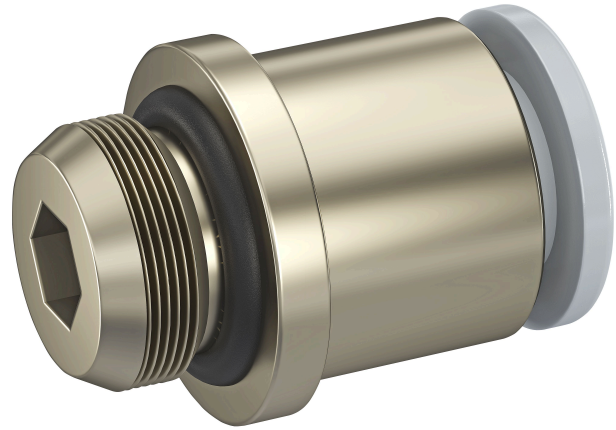

Datos técnicos

Sector	Industria
Certificado	RoHS
Orificio G	1/8" BSP
Fluido	Aire comprimido
Presión de funcionamiento mín.	0.95 bar
Presión de funcionamiento máx.	10 bar
Temperatura ambiente mín.	-10 °C
Temperatura ambiente máx.	60 °C
Cantidad de suministro	5 Unidades

Material

Material carcasa	Latón, niquelada
Material juntas	Caucho de nitrilo-butadieno hidrogenado
N° de material	K599AU571903185

Racor recto, 1/8" BSP

K599AU571903185

2025-01-06

Dimensiones

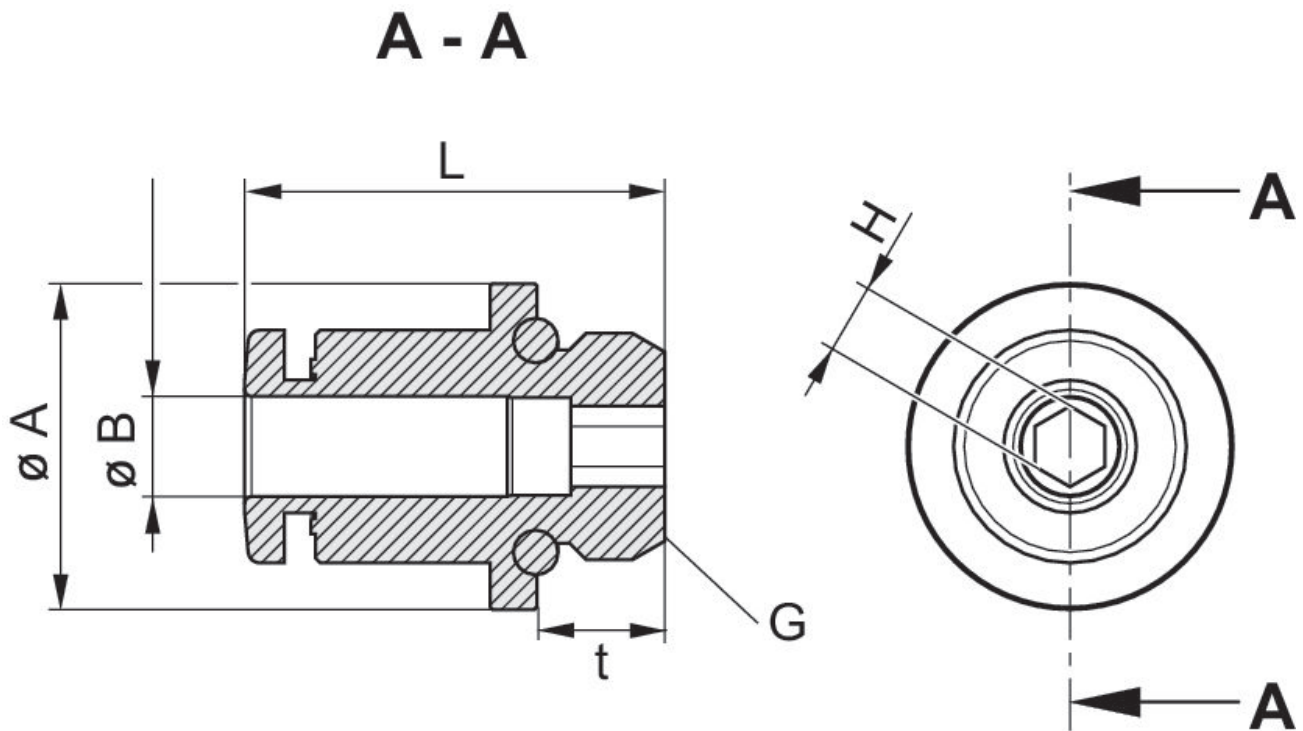

N° de material	Orificio G t=profundidad de rosca	A	B	L	H	Cantidad de suministro	Par de apriete recomendado
K599AU571903142	1/8" BSP t=5,5	14	4-5/32"	18,05	3	2	6,0 ± 1,2 Nm
K599AU571903145	1/8" BSP t=5,5	14	4-5/32"	18,05	3	5	6,0 ± 1,2 Nm
K599AU571903140	1/8" BSP t=5,5	14	4-5/32"	18,05	3	10	6,0 ± 1,2 Nm
K599AU571903162	1/8" BSP t=5,5	14	6	19,65	4	2	6,0 ± 1,2 Nm
K599AU571903165	1/8" BSP t=5,5	14	6	19,65	4	5	6,0 ± 1,2 Nm
K599AU571903160	1/8" BSP t=5,5	14	6	19,65	4	10	6,0 ± 1,2 Nm
K599AU571903182	1/8" BSP t=5,5	14	8	24,75	6*	2	6,0 ± 1,2 Nm
K599AU571903185	1/8" BSP t=5,5	14	8	24,75	6*	5	6,0 ± 1,2 Nm
K599AU571903180	1/8" BSP t=5,5	14	8	24,75	6*	10	6,0 ± 1,2 Nm