

Straight fitting, 1/8" BSP

K599AU571903162

2025-01-06

Mechanical accessories

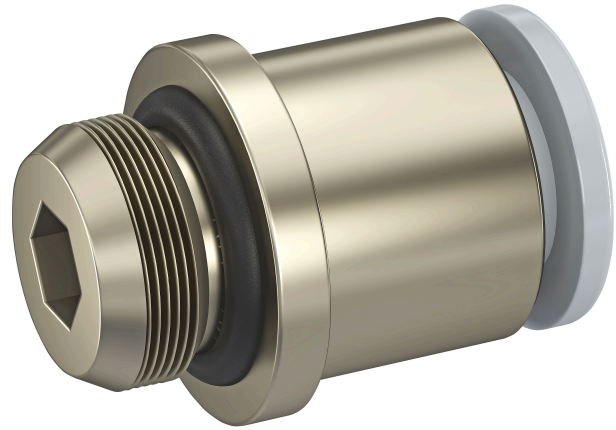

Technical data

Industry	Industrial
Certificate	RoHS
Port G	1/8" BSP
Medium	Compressed air
Min. working pressure	0.95 bar
Max. working pressure	10 bar
Min. ambient temperature	-10 °C
Max. ambient temperature	60 °C
Delivery quantity	2 piece

Material

Housing material	Brass, nickel-plated
Seal material	Hydrogenated nitrile butadiene rubber
Part No.	K599AU571903162

Straight fitting, 1/8" BSP

K599AU571903162

2025-01-06

Dimensions

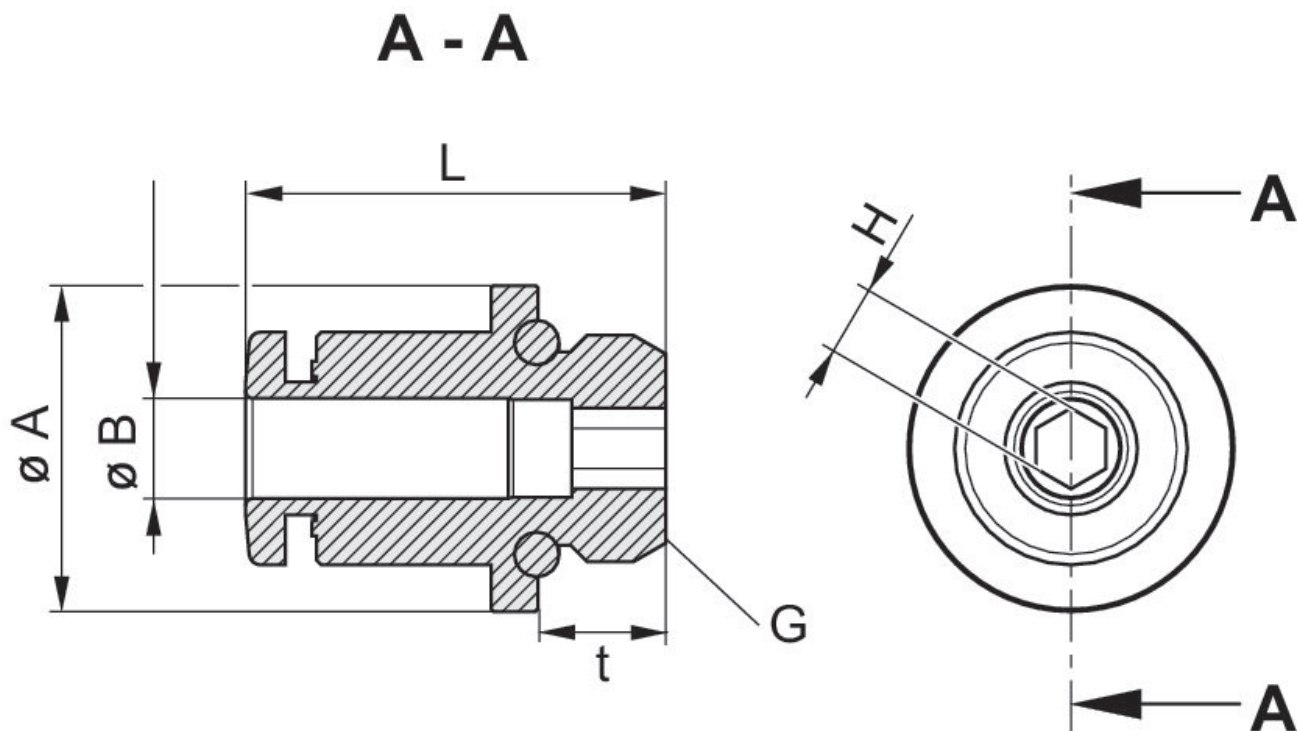

Part No.	Port G t=depth of thread	A	B	L	H	Delivery quantity	Recom- mended tightening torque
K599AU571903142	1/8" BSP t=5,5	14	4-5/32"	18,05	3	2	6,0 ± 1,2 Nm
K599AU571903145	1/8" BSP t=5,5	14	4-5/32"	18,05	3	5	6,0 ± 1,2 Nm
K599AU571903140	1/8" BSP t=5,5	14	4-5/32"	18,05	3	10	6,0 ± 1,2 Nm
K599AU571903162	1/8" BSP t=5,5	14	6	19,65	4	2	6,0 ± 1,2 Nm
K599AU571903165	1/8" BSP t=5,5	14	6	19,65	4	5	6,0 ± 1,2 Nm
K599AU571903160	1/8" BSP t=5,5	14	6	19,65	4	10	6,0 ± 1,2 Nm
K599AU571903182	1/8" BSP t=5,5	14	8	24,75	6*	2	6,0 ± 1,2 Nm
K599AU571903185	1/8" BSP t=5,5	14	8	24,75	6*	5	6,0 ± 1,2 Nm
K599AU571903180	1/8" BSP t=5,5	14	8	24,75	6*	10	6,0 ± 1,2 Nm

* The tightening tool should be at least 14 mm long on its H length.