

Gerade Verschraubung, 1/8" BSP

K599AU571903162

2025-01-06

Mechanisches Zubehör

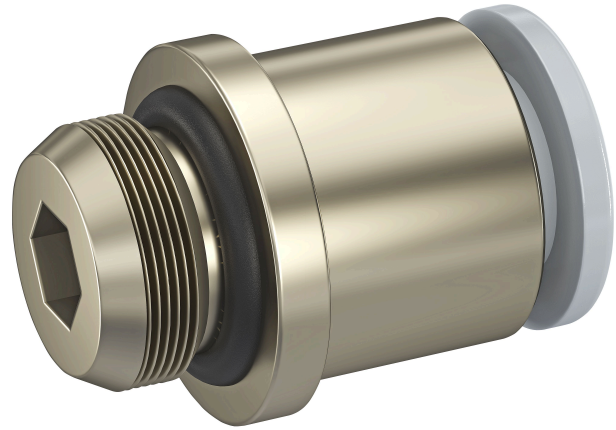

Technische Daten

Branche	Industrie
Zertifikat	RoHS
Anschluss G	1/8" BSP
Medium	Druckluft
Betriebsdruck min.	0.95 bar
Betriebsdruck max.	10 bar
Umgebungstemperatur min.	-10 °C
Umgebungstemperatur max.	60 °C
Liefermenge	2 Stück

Werkstoff

Werkstoff Gehäuse	Messing, vernickelt
Werkstoff Dichtungen	Hydrierter Nitril-Butadien-Kautschuk
Materialnummer	K599AU571903162

Gerade Verschraubung, 1/8" BSP

K599AU571903162

2025-01-06

Abmessungen

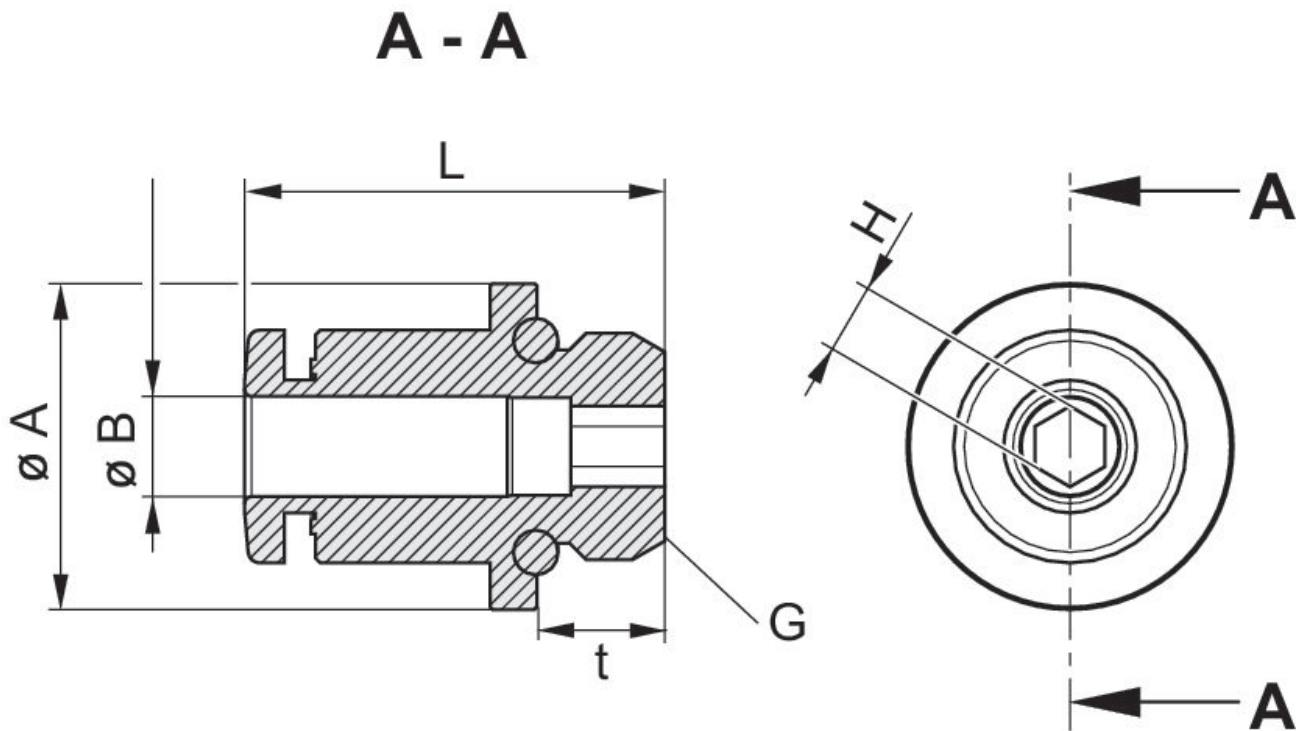

Materialnummer	Anschluss G t=Ge- windtiefe	A	B	L	H	Liefermenge	Empfohle- nes Anzugs- moment
K599AU571903142	1/8" BSP t=5,5	14	4-5/32"	18,05	3	2	6,0 ± 1,2 Nm
K599AU571903145	1/8" BSP t=5,5	14	4-5/32"	18,05	3	5	6,0 ± 1,2 Nm
K599AU571903140	1/8" BSP t=5,5	14	4-5/32"	18,05	3	10	6,0 ± 1,2 Nm
K599AU571903162	1/8" BSP t=5,5	14	6	19,65	4	2	6,0 ± 1,2 Nm
K599AU571903165	1/8" BSP t=5,5	14	6	19,65	4	5	6,0 ± 1,2 Nm
K599AU571903160	1/8" BSP t=5,5	14	6	19,65	4	10	6,0 ± 1,2 Nm
K599AU571903182	1/8" BSP t=5,5	14	8	24,75	6*	2	6,0 ± 1,2 Nm
K599AU571903185	1/8" BSP t=5,5	14	8	24,75	6*	5	6,0 ± 1,2 Nm
K599AU571903180	1/8" BSP t=5,5	14	8	24,75	6*	10	6,0 ± 1,2 Nm

* Die Länge des Spannwerkzeugs sollte mindestens 14 mm betragen.