

Raccordo diritto, 1/8" BSP

K599AU571903160

2025-01-06

Accessori meccanici

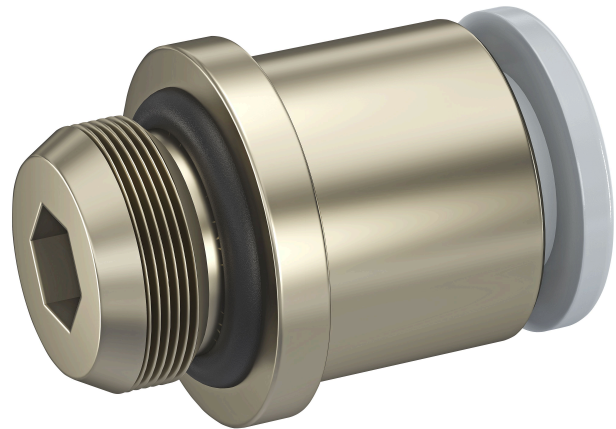

Dati tecnici

Settore

Industria

Certificato

RoHS

Raccordo G

1/8" BSP

Fluido

Aria compressa

Pressione di esercizio min.

0.95 bar

Pressione di esercizio max

10 bar

Temperatura ambiente min.

-10 °C

Temperatura ambiente max.

60 °C

Confezione

10 Pezzo

Materiale

Materiale corpo

Ottone nichelato

Materiale guarnizioni

Gomma nitrile-butadiene idrogenata

Codice

K599AU571903160

Raccordo diretto, 1/8" BSP

K599AU571903160

2025-01-06

Dimensioni

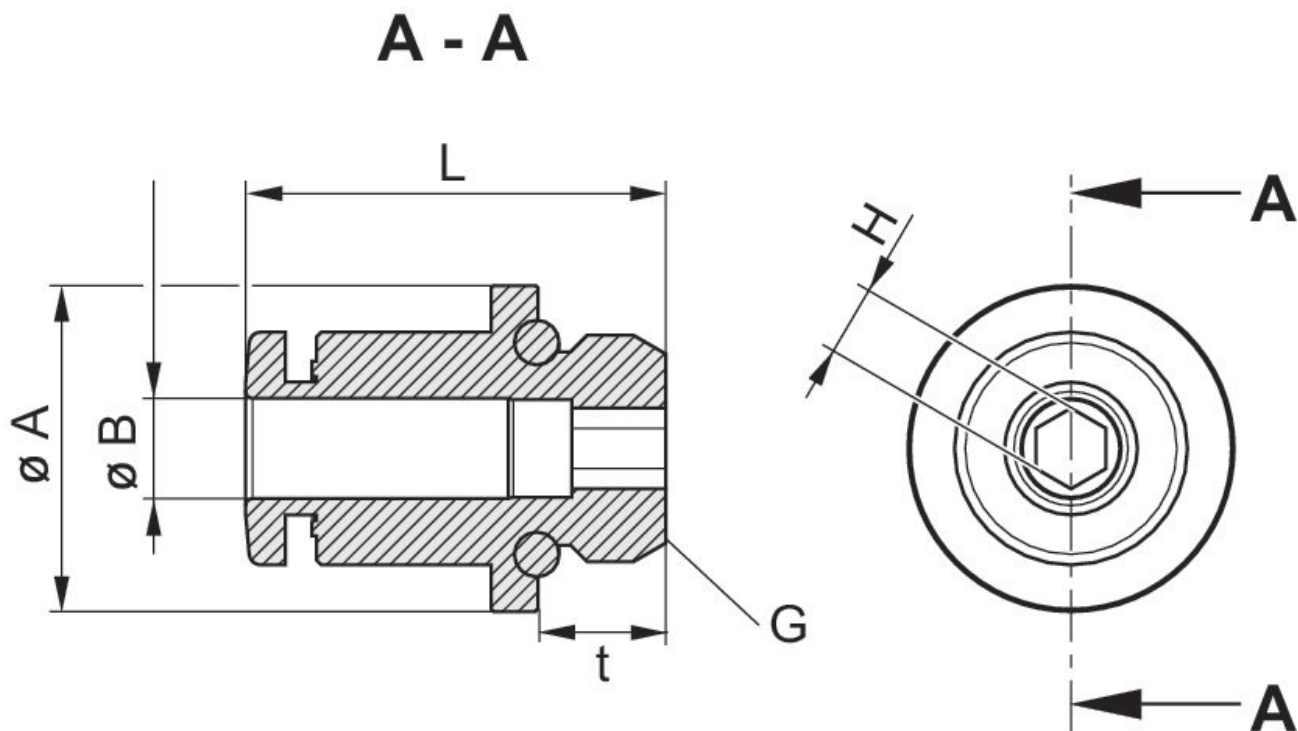

Codice	Raccordo G t=profondità filettatura	A	B	L	H	Confezione	Coppia di serraggio consigliata
K599AU571903142	1/8" BSP t=5,5	14	4-5/32"	18,05	3	2	6,0 ± 1,2 Nm
K599AU571903145	1/8" BSP t=5,5	14	4-5/32"	18,05	3	5	6,0 ± 1,2 Nm
K599AU571903140	1/8" BSP t=5,5	14	4-5/32"	18,05	3	10	6,0 ± 1,2 Nm
K599AU571903162	1/8" BSP t=5,5	14	6	19,65	4	2	6,0 ± 1,2 Nm
K599AU571903165	1/8" BSP t=5,5	14	6	19,65	4	5	6,0 ± 1,2 Nm
K599AU571903160	1/8" BSP t=5,5	14	6	19,65	4	10	6,0 ± 1,2 Nm
K599AU571903182	1/8" BSP t=5,5	14	8	24,75	6*	2	6,0 ± 1,2 Nm
K599AU571903185	1/8" BSP t=5,5	14	8	24,75	6*	5	6,0 ± 1,2 Nm
K599AU571903180	1/8" BSP t=5,5	14	8	24,75	6*	10	6,0 ± 1,2 Nm