

Raccordo diritto, 1/8" BSP

K599AU571903145

2025-01-06

Accessori meccanici

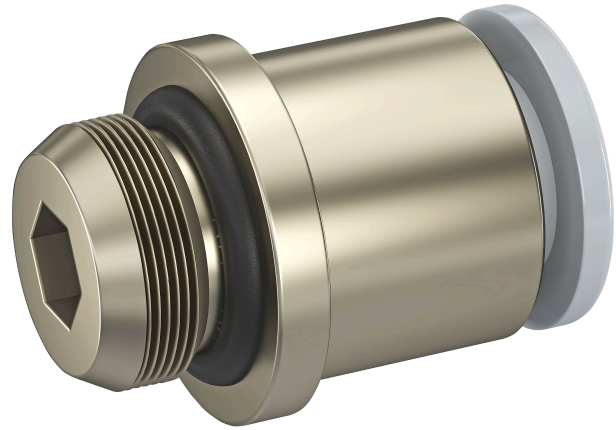

Dati tecnici

Settore	Industria
Certificato	RoHS
Raccordo G	1/8" BSP
Fluido	Aria compressa
Pressione di esercizio min.	0.95 bar
Pressione di esercizio max	10 bar
Temperatura ambiente min.	-10 °C
Temperatura ambiente max.	60 °C
Confezione	5 Pezzo

Materiale

Materiale corpo	Ottone nichelato
Materiale guarnizioni	Gomma nitrile-butadiene idrogenata
Codice	K599AU571903145

Raccordo diretto, 1/8" BSP

K599AU571903145

2025-01-06

Dimensioni

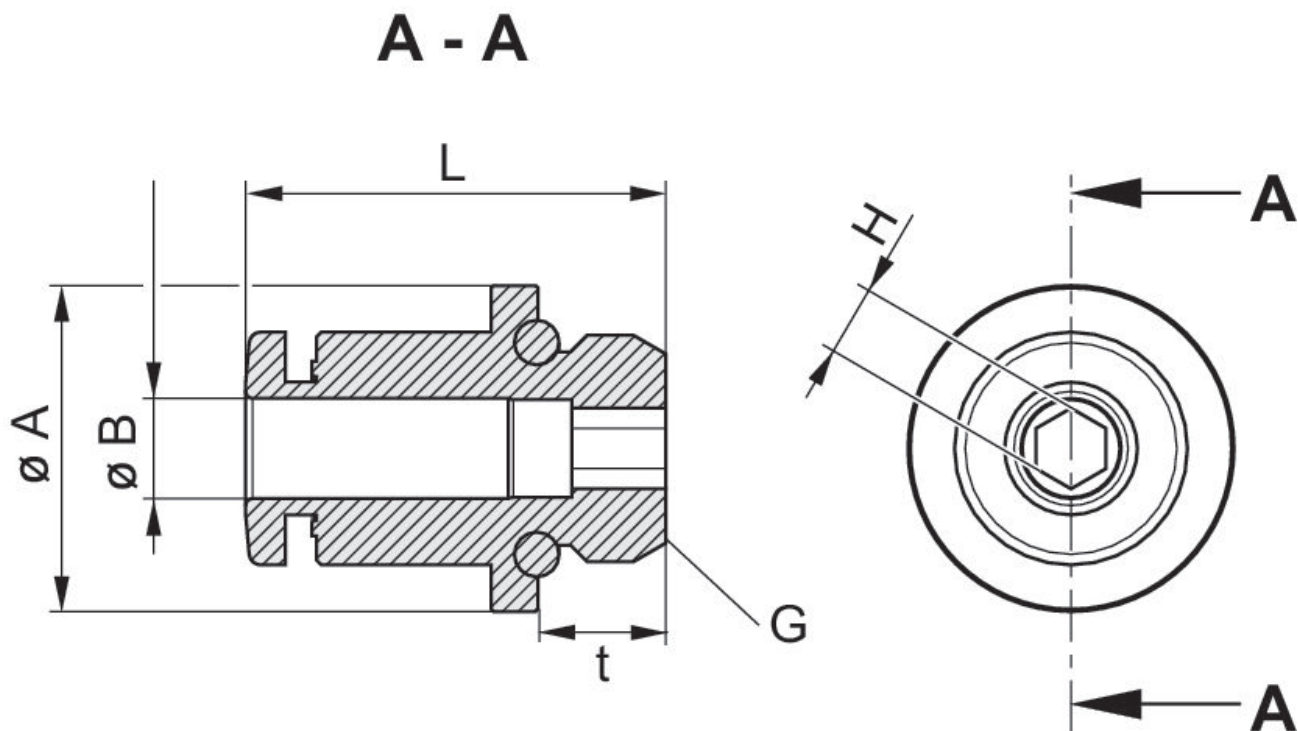

Codice	Raccordo G t=profondità filettatura	A	B	L	H	Confezione	Coppia di serraggio consigliata
K599AU571903142	1/8" BSP t=5,5	14	4-5/32"	18,05	3	2	6,0 ± 1,2 Nm
K599AU571903145	1/8" BSP t=5,5	14	4-5/32"	18,05	3	5	6,0 ± 1,2 Nm
K599AU571903140	1/8" BSP t=5,5	14	4-5/32"	18,05	3	10	6,0 ± 1,2 Nm
K599AU571903162	1/8" BSP t=5,5	14	6	19,65	4	2	6,0 ± 1,2 Nm
K599AU571903165	1/8" BSP t=5,5	14	6	19,65	4	5	6,0 ± 1,2 Nm
K599AU571903160	1/8" BSP t=5,5	14	6	19,65	4	10	6,0 ± 1,2 Nm
K599AU571903182	1/8" BSP t=5,5	14	8	24,75	6*	2	6,0 ± 1,2 Nm
K599AU571903185	1/8" BSP t=5,5	14	8	24,75	6*	5	6,0 ± 1,2 Nm
K599AU571903180	1/8" BSP t=5,5	14	8	24,75	6*	10	6,0 ± 1,2 Nm