

# Raccord droit, 1/8" BSP

K599AU571903145

2025-01-06

## Accessoires mécaniques

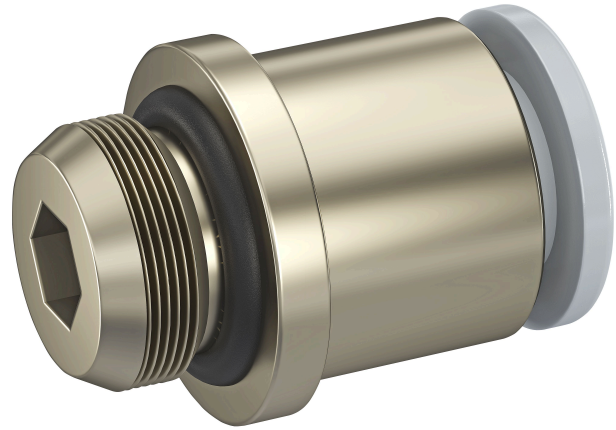

## Données techniques

Secteur	Industrie
Certificat	RoHS
Orifice G	1/8" BSP
Fluide	Air comprimé
Pression de service min.	0.95 bar
Pression de service maxi	10 bar
Température ambiante min.	-10 °C
Température ambiante max.	60 °C
Quantité livrée	5 Pcs.

## Matériau

Matériau boîtiers	Laiton, nickelé
Matériau joints	Caoutchouc nitrile hydraugéné (HNBR)
Référence	K599AU571903145

# Raccord droit, 1/8" BSP

K599AU571903145

2025-01-06

## Dimensions

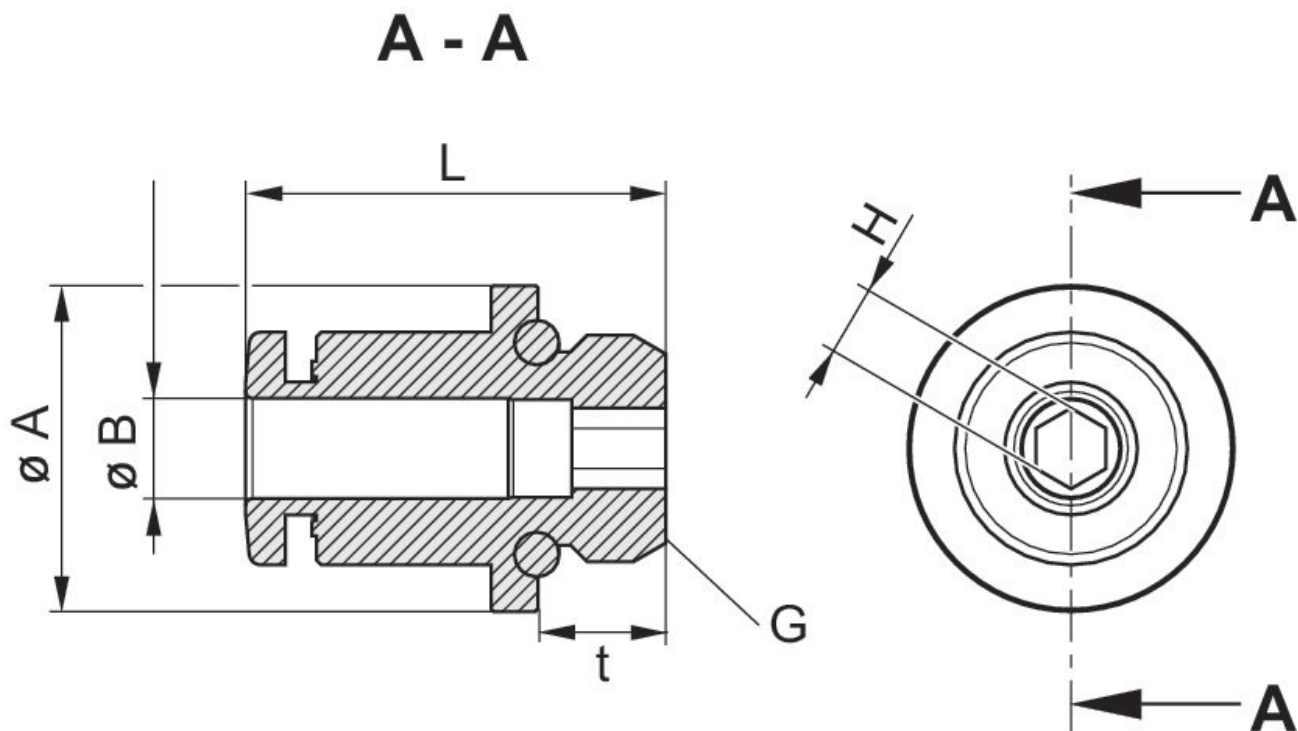

Référence	Orifice G t=profondeur de filet	A	B	L	H	Quantité livrée	Couple de serrage $M_A$ conseillé
K599AU571903142	1/8" BSP t=5,5	14	4-5/32"	18,05	3	2	6,0 ± 1,2 Nm
K599AU571903145	1/8" BSP t=5,5	14	4-5/32"	18,05	3	5	6,0 ± 1,2 Nm
K599AU571903140	1/8" BSP t=5,5	14	4-5/32"	18,05	3	10	6,0 ± 1,2 Nm
K599AU571903162	1/8" BSP t=5,5	14	6	19,65	4	2	6,0 ± 1,2 Nm
K599AU571903165	1/8" BSP t=5,5	14	6	19,65	4	5	6,0 ± 1,2 Nm
K599AU571903160	1/8" BSP t=5,5	14	6	19,65	4	10	6,0 ± 1,2 Nm
K599AU571903182	1/8" BSP t=5,5	14	8	24,75	6*	2	6,0 ± 1,2 Nm
K599AU571903185	1/8" BSP t=5,5	14	8	24,75	6*	5	6,0 ± 1,2 Nm
K599AU571903180	1/8" BSP t=5,5	14	8	24,75	6*	10	6,0 ± 1,2 Nm