

# Standard oil-mist lubricator, Series 651

G651AL0K10A0000

General series information  
Series 651

- The AVENTICS Series 651 is an easy-to-install line of pneumatic filters, regulators and lubricators (FRLs) that offer the industry's highest flow rates and widest temperature ratings. Available in 1/8-inch, and 1/4-inch port sizes, these FRLs are ideal for automotive and tire, packaging, food and beverage, and process applications requiring highly reliable operation and robust, modern-looking equipment.



## Technical data

Industry	Industrial
Parts	Lubricator
Reservoir	Metal reservoir without window
Compressed air connection	G 1/8
Nominal flow Qn	900 l/min
Working pressure min.	0 bar
Working pressure max	10 bar
Min. ambient temperature	5 °C
Max. ambient temperature	50 °C
Medium	Compressed air Neutral gases
Certificates	ATEX optional
Lubricator reservoir volume	42 cm <sup>3</sup>
Function	Oil-mist lubricator

Function Can be assembled into blocks  
Weight 0.33 kg

## Material

Housing material Aluminum  
Material front plate Polycarbonate  
Seal material Nitrile butadiene rubber  
Material reservoir Aluminum  
Part No. G651AL0K10A0000

## Technical information

Recommended oil type  
Non-detergent type and without aggressive additives (VG32-ISO3448)

## Dimensions

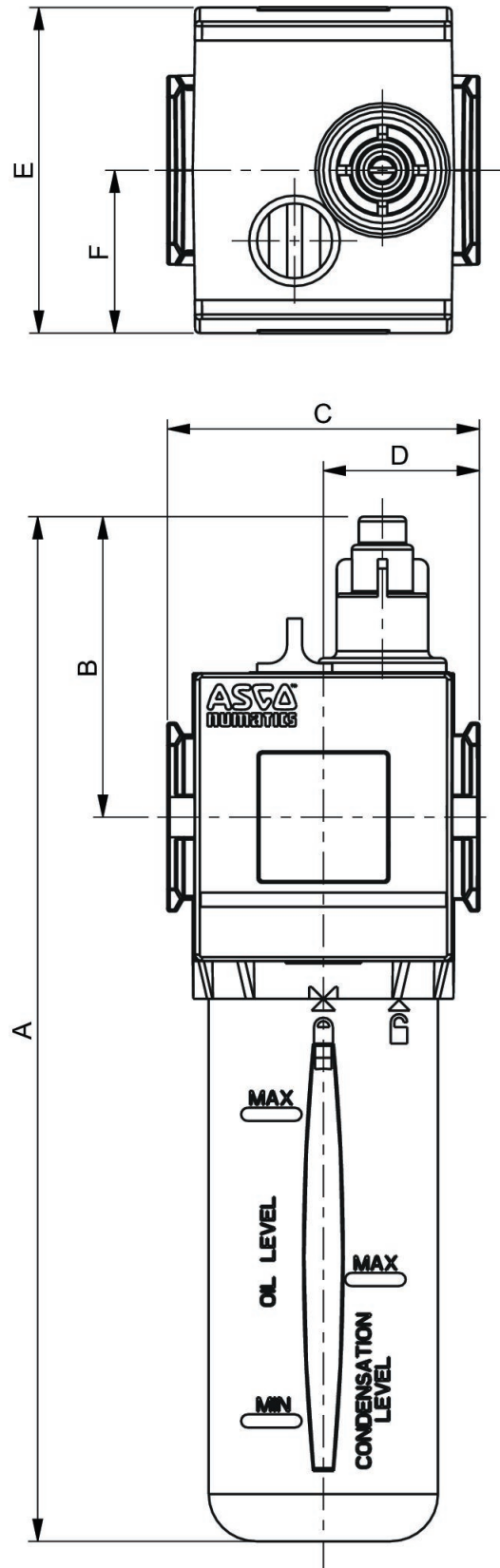

To remove the reservoir, allow a clearance of [[20] mm] from the bottom of the reservoir drain.

Series	651
A	198
B	58
C	50
D	25
E	58
F	29

## Accessories overview

