



## Datos técnicos

Sector

Industria

Tipo

MSC-20 / 25

Nº de material

7472D00625

## Dimensiones

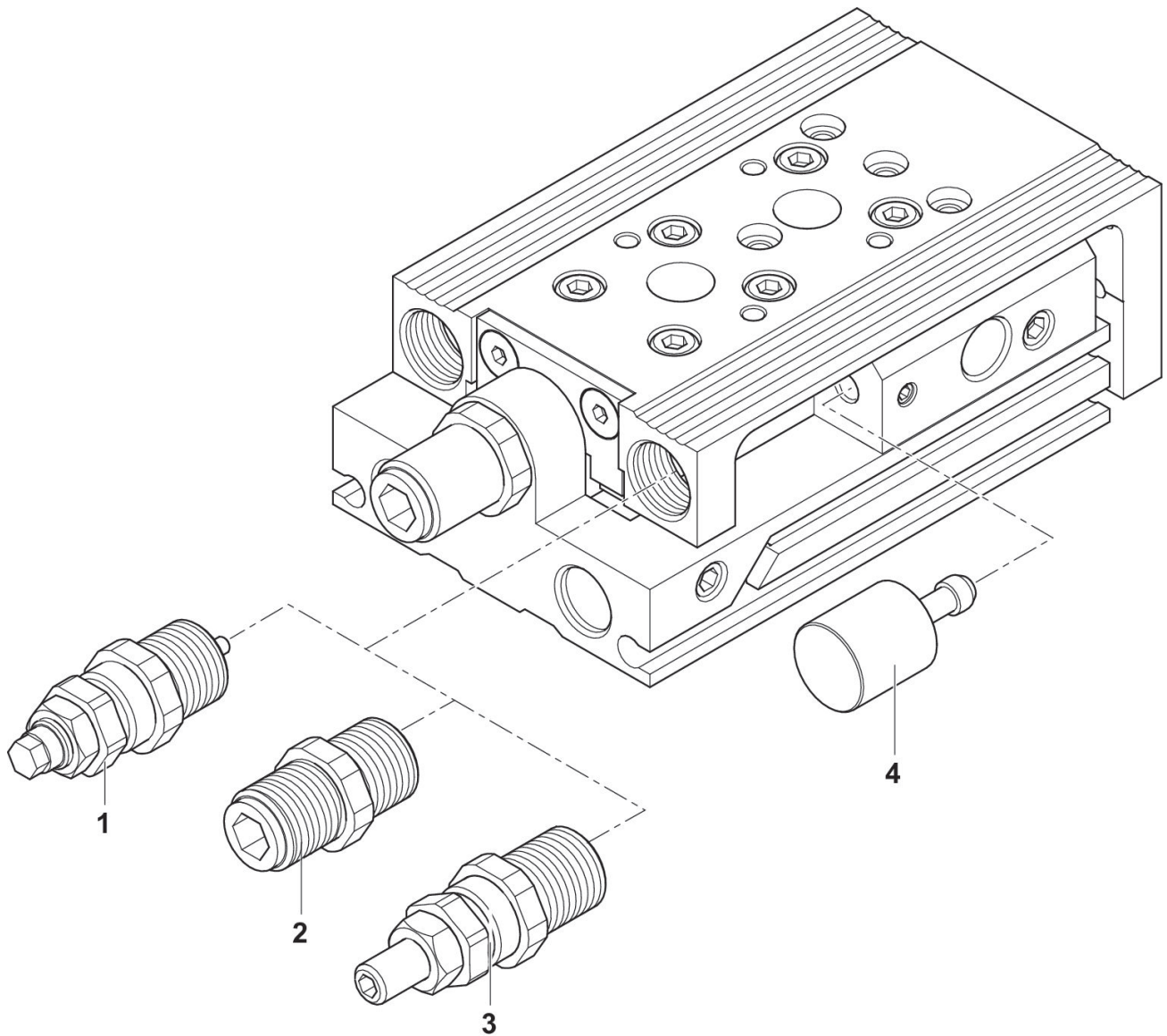

N° de material	Tipo	Piezas sueltas	Carrera	Limitación de carrera adicional en mm	Ø8	Ø12	Ø16	Ø20	Ø25
R422100795	MSC-08-HM	1)	-	-	-	MSC-HM	-	-	-
R422100796	MSC-08-EE	2)	-	-	-	MSC-EE	-	-	-
R422100797	MSC-12-HM	1)	-	-	-	-	MSC-HM	MSC-HM	-
R422100798	MSC-12-EE	2)	-	-	-	-	MSC-EE	MSC-EE	-
R422100799	MSC-20-HM	1)	-	-	-	-	-	-	MSC-HM
R422100800	MSC-20-EE	2)	-	-	-	-	-	-	MSC-EE
R422100801	MSC-25-HM	1)	-	-	-	-	-	-	MSC-HM
R422100802	MSC-25-EE	2)	-	-	-	-	-	-	MSC-EE
R412021913	MSC-08-EM	3)	-	-	MSC-EM	-	-	-	-

# Accesorios de ajuste de carrera

2024-01-19

7472D00625

N° de material	Tipo	Piezas sueltas	Carrera	Limitación de carrera adicional en mm	Ø8	Ø12	Ø16	Ø20	Ø25
R412021914	MSC-12-EM	3)	-	-	-	MSC-EM	MSC-EM	-	-
R412021915	MSC-20-EM	3)	-	-	-	-	-	MSC-EM	-
R412021916	MSC-25-EM	3)	-	-	-	-	-	-	MSC-EM
7472D00616	MSC-08	4)	30-80	10	-	-	-	-	-
7472D00626	MSC-08	4)	30-80	20	-	-	-	-	-
R412021836	MSC-08	4)	40-80	30	-	-	-	-	-
7472D00620	MSC-12 / 16	4)	30-100 / 30-150	10	-	-	-	-	-
7472D00619	MSC-12 / 16	4)	30-100 / 30-150	20	-	-	-	-	-
R412022650	MSC-12 / 16	4)	30-100 / 30-150	30	-	-	-	-	-
7472D00623	MSC-20 / 25	4)	30-200	10	-	-	-	-	-
7472D00622	MSC-20 / 25	4)	30-200	20	-	-	-	-	-
7472D00625	MSC-20 / 25	4)	40-200	30	-	-	-	-	-