

AVENTICS Series EBP Ejectors

AVENTICS EBP Series are simple stage vacuum ejectors pneumatically controlled. EBE vacuum ejectors are robust, compact, easy to install and with a low sound level.

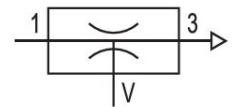
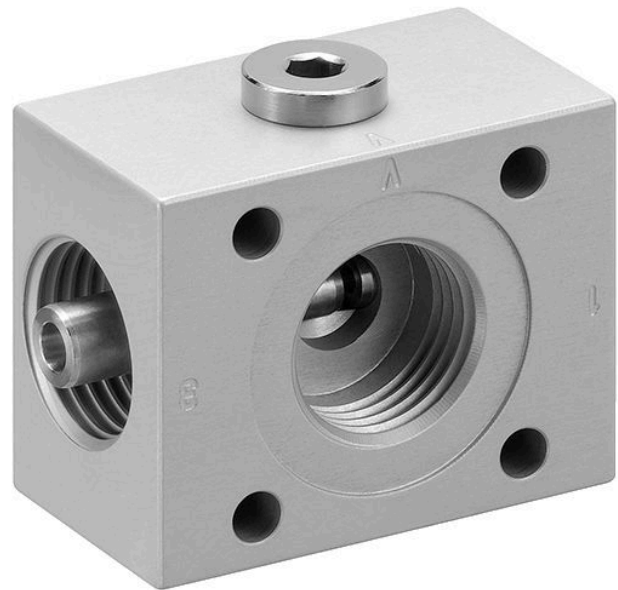

Technical data

Industry	Industrial
Activation	Pneumatically
Nozzle Ø	1 mm
Min. working pressure	2 bar
Max. working pressure	6 bar
Min. ambient temperature	0 °C
Max. ambient temperature	50 °C
Min. medium temperature	0 °C
Max. medium temperature	60 °C
Medium	Compressed air
Min. oil content of compressed air	0 mg/m ³
Max. oil content of compressed air	1 mg/m ³
Max. particle size	5 µm
Max. suction capacity	40 l/min
Air consumption at p.opt.	60 l/min
Max. vacuum level at p.opt.	89 %
Weight	0.13 kg
Housing material	Aluminum
Surface housing	anodized

Seal material	Acrylonitrile butadiene rubber
Nozzle material	Brass
Part No.	7350600000

Technical information

Note: All data refers to an ambient pressure of $[[1,013]$ bar] and an ambient temperature of $[[20]^{\circ}\text{C}]$.
 The pressure dew point must be at least 15°C less than ambient and medium temperature and may not exceed 3°C .

The oil content of compressed air must remain constant during the life cycle.

EBP-PT-10 .../ -30

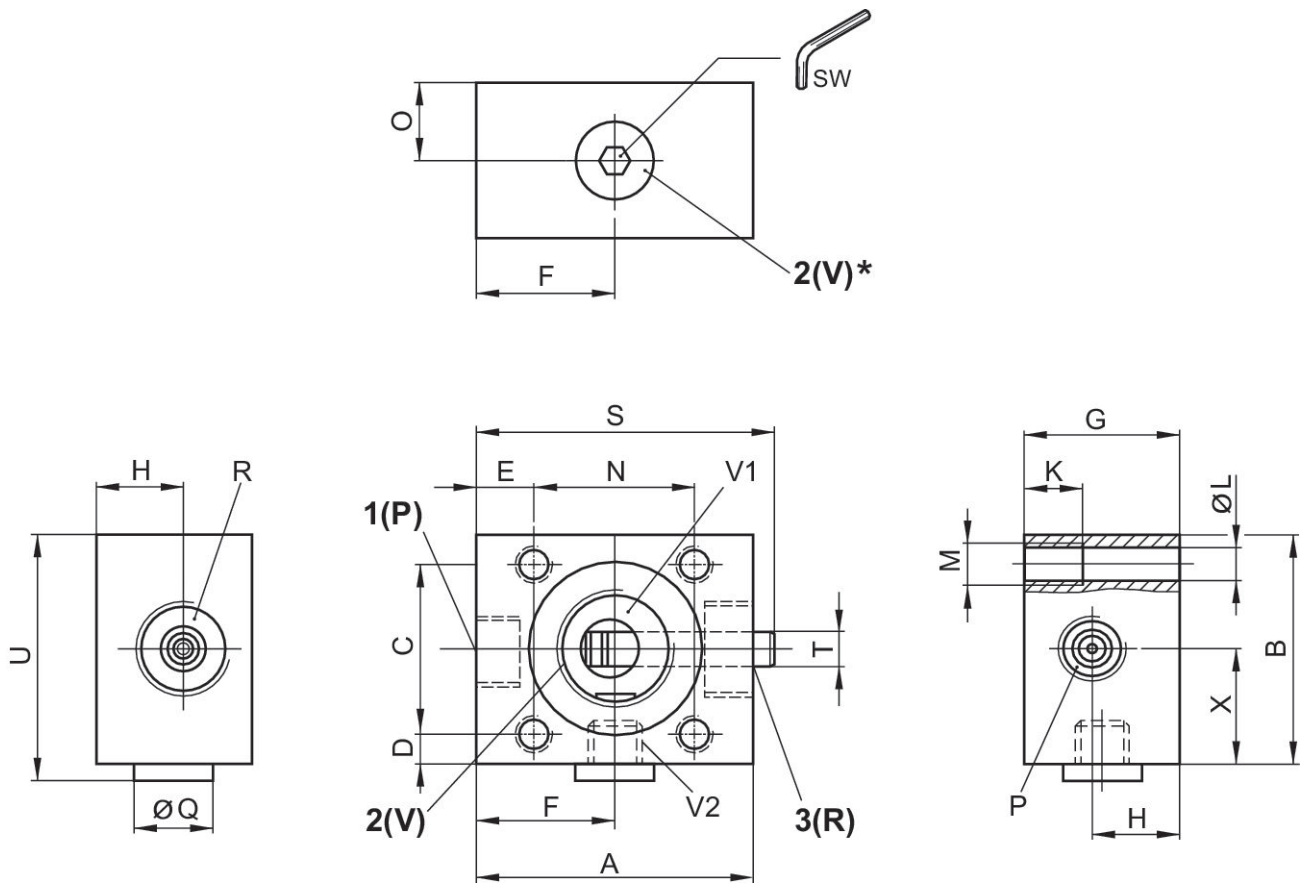

* Compressed air connection for pressure sensor

Part No.	A	B	C	D	E	F	G	H	K
7350150000	40	25	16	4.5	9	20	25	12.5	10
7350300000	50	25	16	4.5	12	23	25	12.5	10
7350600000	50	40	29	5.5	10.5	25	28	15.5	12

Part No.	A	B	C	D	E	F	G	H	K
7351200000	50	40	29	5.5	10.5	25	28	15.5	12
7352400000	60	40	29	5.5	10.5	25	40	21.5	12
7354200000	60	40	29	5.5	10.5	25	40	21.5	12

Part No.	Ø L	M	N	O	P 1)	Ø Q	R	S	SW
7350150000	5.1	M6	22	10	G 1/8x8	14	G 1/8x8	—	5
7350300000	5.1	M6	22	10	G 1/8x8	14	G 1/8x8	—	5
7350600000	5.1	M6	29	14	G 1/4x10	14	G 3/8x9	—	5
7351200000	5.1	M6	29	14	G 1/4x10	14	—	52.5	5
7352400000	5.1	M6	29	21.5	G 1/4x10	14	G 1x12	—	5
7354200000	5.1	M6	29	21.5	G 1/4x10	14	G 1x12	—	5

Part No.	Ø T	U	V1 2)	V2 3)	X
7350150000	5	28	G 1/8x8	G 1/8x7	12,5
7350300000	—	28.5	G 1/8x8	G 1/8x7	12,5
7350600000	8	43	G 1/2x9	G 1/8x8	20
7351200000	8	43	G 1/2x9	G 1/8x8	20
7352400000	—	43	G 1/2x9	G 1/8x8	20
7354200000	—	43	G 1/2x9	G 1/8x8	20

- 1) Inlet
- 2) Suction connection

- 3) Variable connection for vacuum

Vacuum p₂ depending on working pressure p₁

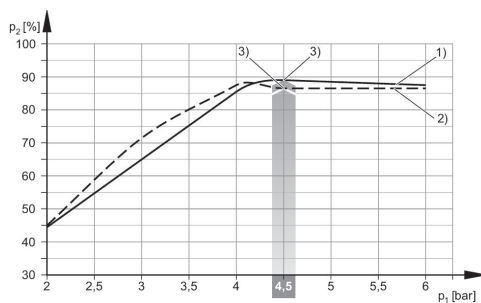

- 1) Ø nozzle 1.0 mm
- 2) Ø nozzle 1.5 mm
- 3) optimum working pressure

Suction capacity q_s depending on working pressure p₁

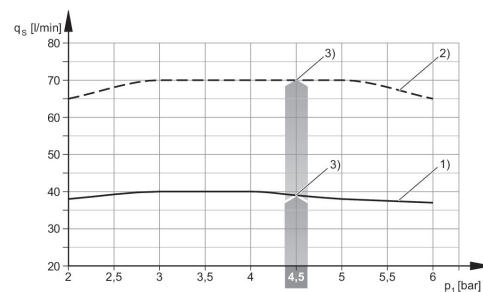

- 1) Ø nozzle 1.0 mm
- 2) Ø nozzle 1.5 mm
- 3) optimum working pressure

Air consumption q_v depending on working pressure p_1

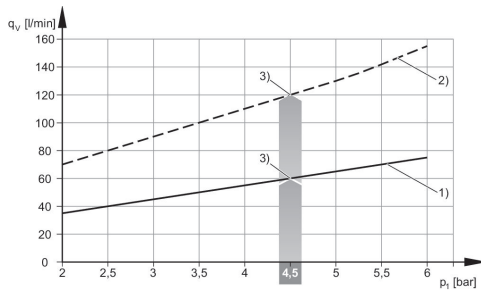

- 1) \varnothing nozzle 1.0 mm
- 2) \varnothing nozzle 1.5 mm
- 3) optimum working pressure

Evacuation time t_E depending on vacuum p_2 for 1 l volume (with optimal operating pressure p_{1opt})

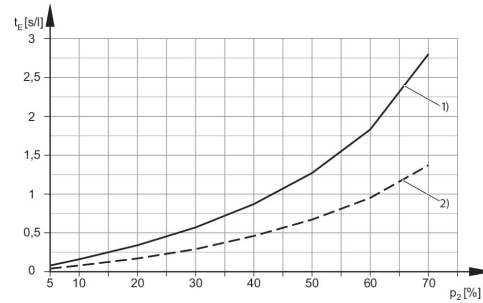

- 1) \varnothing nozzle 1.0 mm
- 2) \varnothing nozzle 1.5 mm