

5735040300

AVENTICS Series 573 Quick exhaust valves

The AVENTICS Quick exhaust valve, Series 573 is designed for high flow applications thanks to an exhaust flow up to 12000 l/min.

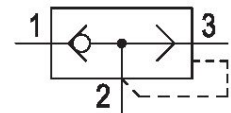

Technical data

Industry	Industrial
Type	Poppet valve
Medium	Compressed air
Compressed air connection input	G 1/2
Compressed air connection type 1	Internal thread
Compressed air connection 2	G 1/2
Compressed air connection type 2	Internal thread
Port 3 (Exhaust)	G 1/2
Compressed air connection type 3	Internal thread
Nominal flow Qn 1 to 2	3400 l/min
Nominal flow Qn 2 to 3	6100 l/min
Min. working pressure	0.8 bar
Max. working pressure	10 bar
Min. ambient temperature	-18 °C
Max. ambient temperature	70 °C
Min. medium temperature	-18 °C
Max. medium temperature	70 °C
Weight	0.32 kg
Housing material	Brass
Surface housing	nickel-plated
Seal material	Polyurethane
Part No.	5735040300

Quick exhaust valve, Series 573

2023-11-28

5735040300

Fig. 2

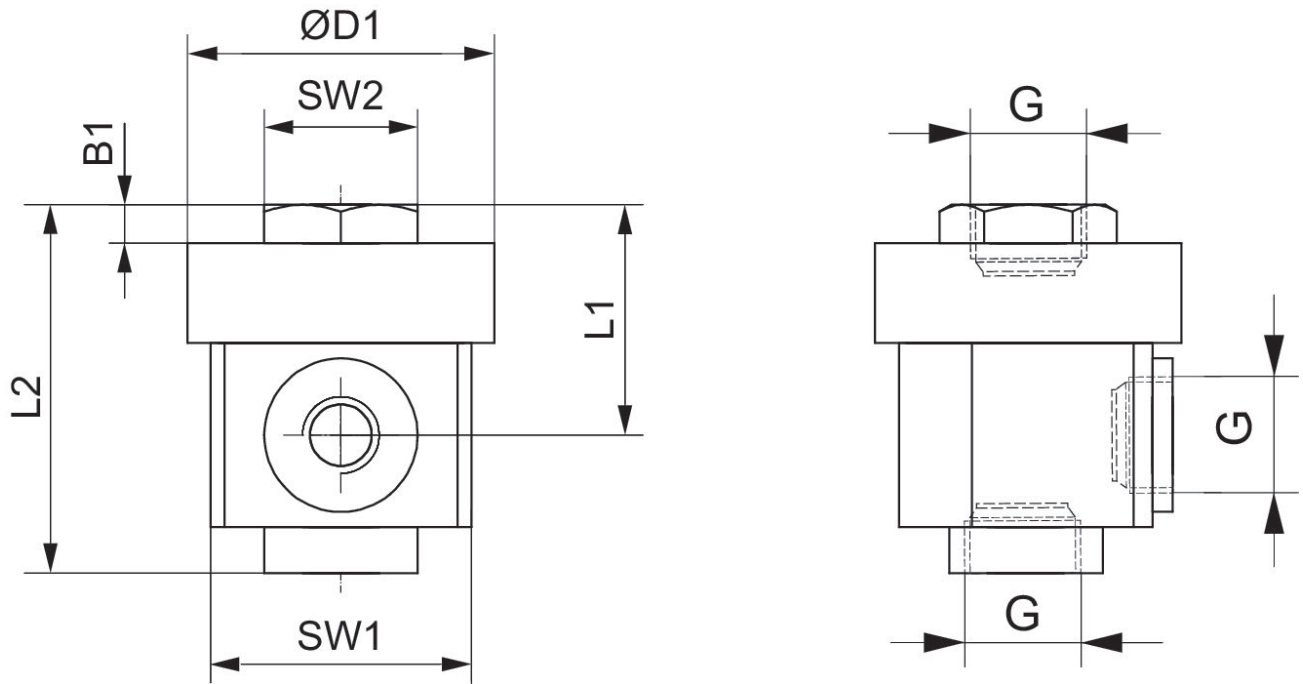

Part No.	Port G	B1	ØD1	L1	L2	SW1	SW2
5735040900	M5	2.5	20	17	25	17	10

Fig. 1

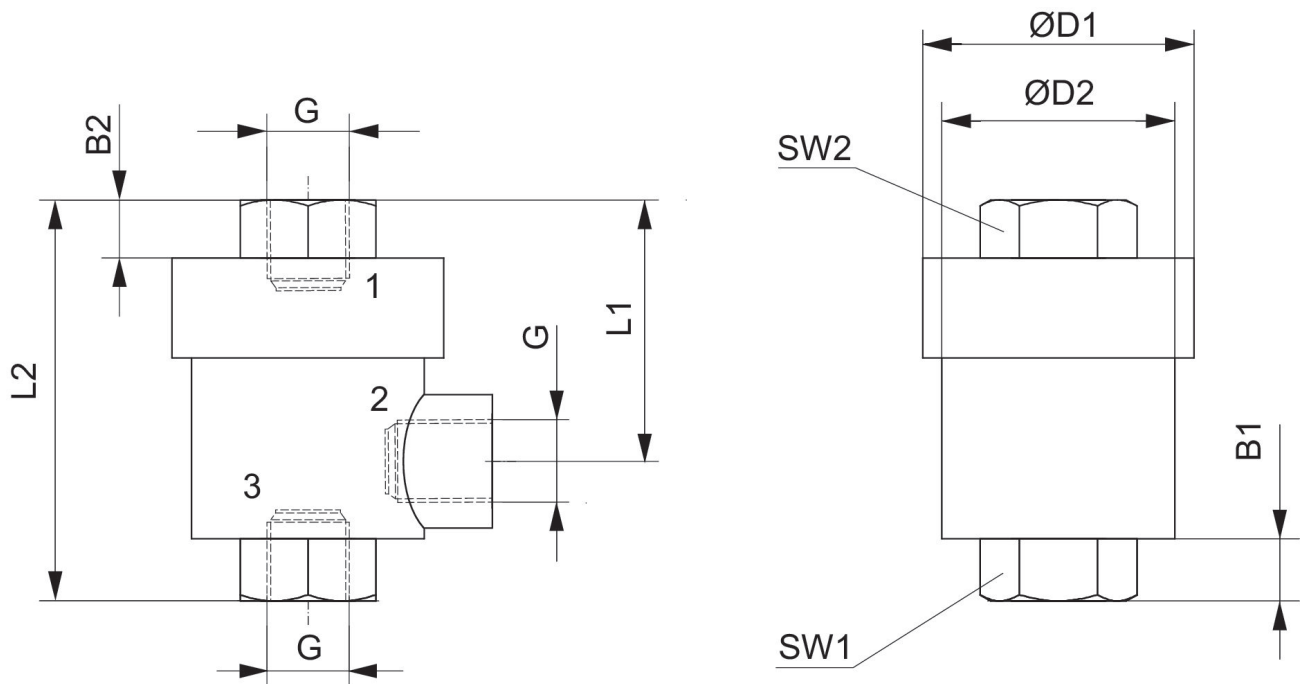

Quick exhaust valve, Series 573

2023-11-28

5735040300

Part No.	Port G	B1	B2	ØD1	ØD2	L1	L2	SW1	SW2
5735040000	G 1/8	6.5	6.5	28	24	27	42	15	15
5735040100	G 1/4	9.5	9	33.5	29.5	35	53	19	19
R412010750	G 3/8	10	10	32.5	29.5	36	56	21	21
R412010751	G 3/4	19	16	49	45.5	55	90	32	32
R412010752	G 1	17	17	80	70	70	110	46	46