

Non-rotating axle AA6, series CM1

5234000082

Bolts

2023-11-14

Bolts



Technical data

Industry

Industrial

Version

For clevis mountings AB6

Piston diameter

80 mm

Axle pivot Ø

20 mm

Material

Housing material

Stainless Steel

Fig.

Fig. 1

Part No.

5234000082

Non-rotating axle AA6, series CM1

5234000082

Bolts

2023-11-14

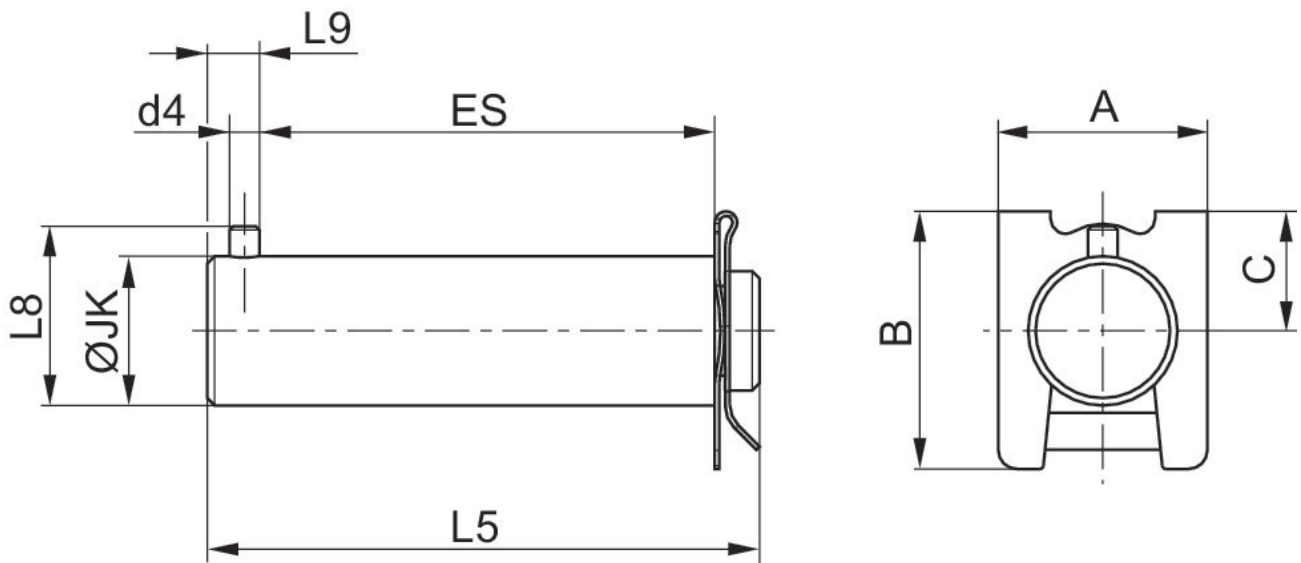

1) circlip DIN 471

Piston Ø	Part No.	A	B	C	Ø d4 H12	JK h9	ES	L5	L8
32	5230000082	18	22	10	3	10	31	41	14
40	5231000082	22	26	12	4	12	36	48	16
50	5232000082	28	34.5	16	4	16	41	54	20
63	5233000082	28	34.5	16	4	16	47	60	20
80	5234000082	28	34.5	16	4	20	63	74	24
100	5235000082	28	34.5	16	4	20	71	84	24

Piston Ø	L9
32	5.5
40	7
50	7
63	7
80	5
100	7