



Technische Daten

Branche

Industrie

für Serie

AR1

Liefereinheit

1 Stück

Gewicht

1.13 kg

Werkstoff

Materialnummer

4519011022

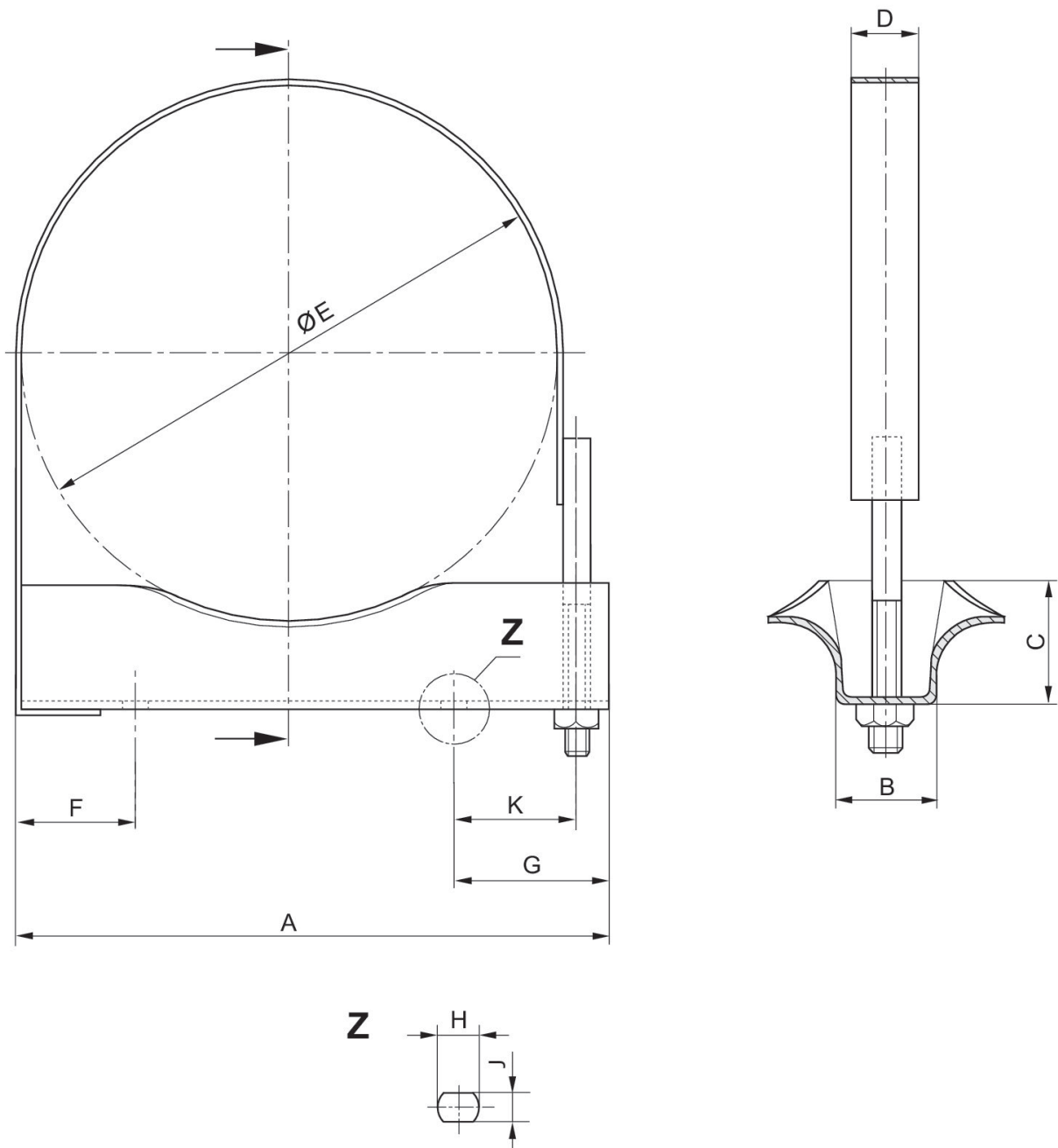

Abmessungen in mm

Material-nummer	A	B	C	D	ØE	F	G	H	J
4519011002	225	36	45	30	206	45	56	16	11
4519011012	265	36	45	30	246	45	56	16	11
4519011022	295	36	45	30	276	45	56	16	11

K
41
41
41