

Base plate, Series 335

35500327

- Versions: aluminum subbases



Technical data

Type
For series
Compressed air connection input
Compressed air connection output
Port exhaust

Base plate
519
G 1/8
M5
G 1/8

Scope of delivery

The manifold base plates are supplied with screws and seals for valve assembly, as well as 3 plugs for ports 1/3/5.

Working pressure min.
Working pressure max
Min. ambient temperature
Max. ambient temperature
Min. medium temperature
Max. medium temperature
Medium
Max. particle size
Oil content of compressed air min.

0 bar
8 bar
5 °C
50 °C
5 °C
50 °C
Compressed air
Neutral gases
50 µm
0 mg/m³

Oil content of compressed air max.	5 mg/m ³
Max. number of valve positions	5
Weight	0.195 kg

Material

Material base plate	Aluminum
Seal material	caoutchouc/butadiene caoutchouc
Part No.	35500327

Technical information

5 spool valves at most can be simultaneously operated without pressure loss. To operated more valves, pressure must be supplied through appropriate inlets on each side of the subbaseThe spool valves can be mounted in any position without affecting operationThread connection "G" applicable for 1/4 and 3/8 have standard thread according to ISO 228/1 and ISO 7/1. Thread connection "G" applicable for 1/8, have standard thread according to ISO 228/1

The min. control pressure must be adhered to, since otherwise faulty switching and valve failure may result!

The pressure dew point must be at least 15 °C less than ambient and medium temperature and may not exceed 3 °C.

The oil content of compressed air must remain constant during the life cycle.

Use only the approved oils from AVENTICS. Further information can be found in the "Technical information" document (available in <https://www.emerson.com/en-us/support>).

Connection of channels 1/3/5 possible on both sides.

Dimensions

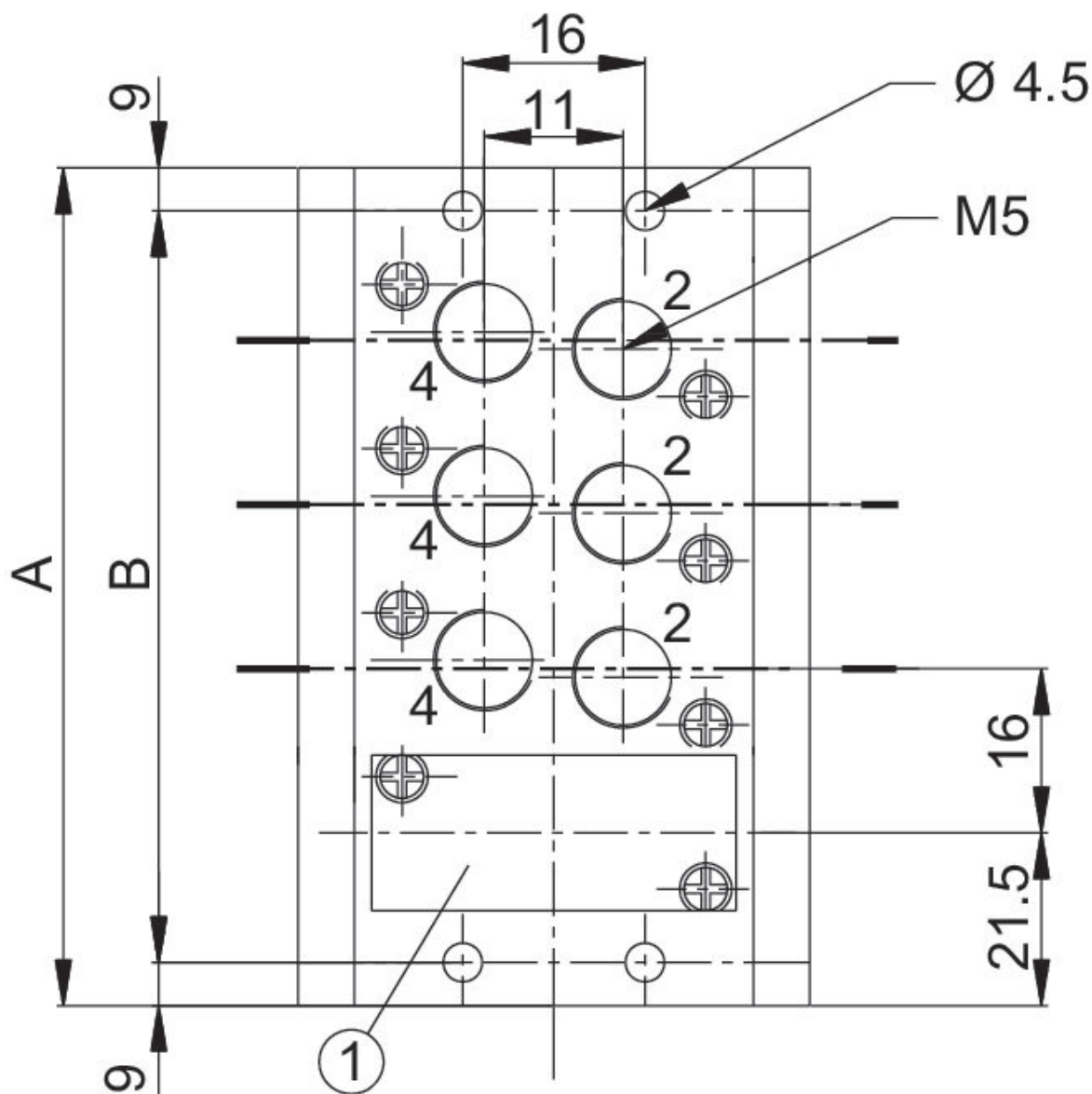
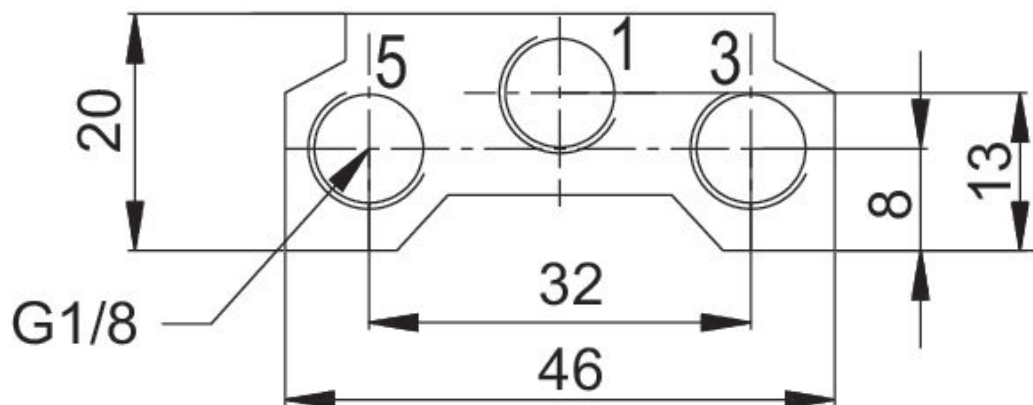

- 1) Flange plate
- 2) Blanking plate

Part No.	A	B
35500324	59	41
35500325	75	57
35500326	91	73
35500327	107	89
35500328	123	105
35500329	139	121
35500330	155	137
35500331	171	153
35500332	187	169