

Series PG1 Pressure gauges

With the AVENTICS Series PG1 you can visualize and rely on a clear air pressure display for each of your pneumatic circuits. In addition to the parameters for controlling the air quality, supplying sufficient pressure is the basis for operating a reliable system within machine automation. Emerson offers mechanical pressure gauges that can be integrated into machines for diverse applications and air preparation systems. The specifications of the individual versions in the universal PG1 Series provide a selection of options, such as appearance, material, or the required type of mounting.



Technical data

Industry	Industrial
Pressure gauge version	Bourdon tube pressure gauge Back port
Standardization	EN 837-1
Class	2,5
Compressed air connection	R 1/8
Nominal diameter	50 mm
Scale value	0.5
Min. range of application	0 bar
Max. range of application	12 bar
Min. display range	0 bar
Max. display range	16 bar
Min. working pressure	0 bar
Max. working pressure	16 bar
Min. ambient temperature	-40 °C
Max. ambient temperature	60 °C
Medium	Compressed air
Background color	White
Main scale unit (outside)	bar
Main scale color (outside)	Black
Secondary scale unit (inside)	psi
Secondary scale color (inside)	Red
Pointer color	Black

Material

Housing material	Acrylonitrile butadiene styrene
Material viewing window	Polystyrene
Material thread	Brass

3530190140

Pressure gauge, Series PG1-STD

2024-05-22

3530190140

Technical information

Order axial seal separately

Dimensions

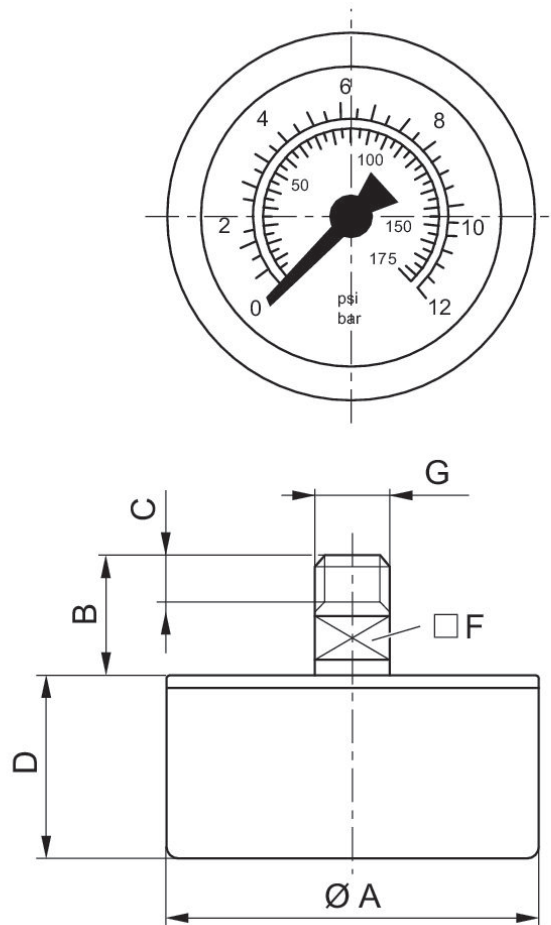

Dimensions in mm

Part No.	Compressed air connection	Nominal diameter	$\varnothing A$	B	C	D	F
8901701290	G 1/8	26 mm	26	15.5	8	16.2	12
8901701270	G 1/8	26 mm	26	15.5	8	16.2	12
3530200130	R 1/8	40 mm	40	19	10	26	14
3530200120	R 1/8	40 mm	40	19	10	26	14
3530200110	R 1/8	40 mm	40	19	10	26	14
3530200100	R 1/8	40 mm	40	19	10	26	14
3530200150	R 1/8	40 mm	40	19	10	26	14

Pressure gauge, Series PG1-STD

2024-05-22

3530190140

Part No.	Compressed air connection	Nominal diameter	Ø A	B	C	D	F
3530200140	R 1/8	40 mm	40	19	10	26	14
3530190150	R 1/8	50 mm	50	19	10	27	14
3530190120	R 1/8	50 mm	50	19	10	27	14
3530190130	R 1/8	50 mm	50	19	10	27	14
3530190110	R 1/8	50 mm	50	19	10	27	14
3530190100	R 1/8	50 mm	50	19	10	27	14
3530190140	R 1/8	50 mm	50	19	10	27	14
8901702070	G 1/4	50 mm	50	18	13	26.5	14
8901702090	G 1/4	63 mm	63	21	13	26.5	14
3530200160	R 1/8	40 mm	40	19	10	26	14
1827231052	M5	26 mm	26	11.5	5	20	12