

# 2/2-way stop valve, Series SC01

## 3520324500

General series information  
AVENTICS Series SC01 Stop valves

- AVENTICS Series SC01 Stop valves are available even in 2/2 or 3/2 construction. SC01 stop valves control flow direction and support a diverse range of system requirements. Our ball valves are both reliable and robust when it comes to service and are available in various configurations and options.

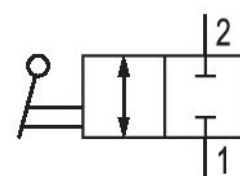

### Technical data

Industry	Industrial
Type	Ball Valve
Switching principle	2/2
Medium	Compressed air
Compressed air connection 1	G 3/4
Compressed air connection type 1	Internal thread
Compressed air connection 2	G 3/4
Compressed air connection type 2	Internal thread
Min. ambient temperature	-20 °C
Max. ambient temperature	150 °C
Min. medium temperature	-20 °C
Max. medium temperature	150 °C
Working pressure min.	-0.8 bar
Working pressure max	40 bar
Weight	0.34 kg

## Material

Housing material	Brass
Housing material	nickel-plated
Seal material	Polytetrafluorethylene
Material hand lever	Steel, chrome-plated
Part No.	3520324500

## Dimensions

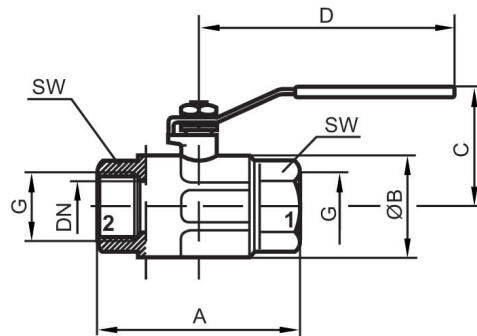

Part No.	Port G	DN	A	Ø B	C	D	SW
3520321500	G 1/4	10	49.5	23.5	41.5	85.5	18
3520322500	G 3/8	10	52.5	24	41.5	85.5	21
3520323500	G 1/2	15	61	30.5	49.8	92.5	25
3520324500	G 3/4	20	68	37	56.3	113.5	31
3520325500	G 1	25	85	45.5	60.3	113.5	38
3520326500	G 1 1/4	32	99.5	58	76.5	138	47
3520327500	G 1 1/2	40	109	71	92	158	54
3520328500	G 2	50	130	85	99	158	66