

Serie QR1



Serie QR1

La serie QR1 AVENTICS di connettori a innesto con montaggio facile e sicuro è disponibile in molte versioni per diametri di tubi da 3 a 16 mm, nelle varianti in plastica, metallo e acciaio inossidabile. La serie QR1 offre una filettatura cilindrica che consente la connessione e la disconnessione ripetute senza problemi (sgancio rapido) e l'O-ring imperdibile garantisce una tenuta ottimale. Il nostro programma QR offre la soluzione adatta a ogni applicazione e settore.

- $Q_n = 60 \text{ l/min} \dots 875 \text{ l/min}$
- A seguito dell'ottimizzazione del prodotto, l'articolo consegnato può differire attualmente dalle dimensioni rappresentate.



Serie QR1-S-RPN standard

Raccordo diretto
filettatura esterna
Raccordo ad innesto



G	Ø D	Unità di fornitura [Pezzo]	Codice
M5	Ø 4	10	2121004050
M5	Ø 6	10	2121006050

2121004050

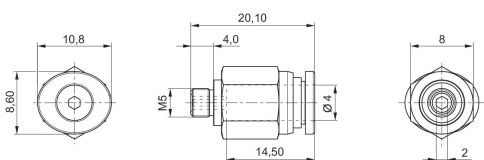

2121006050

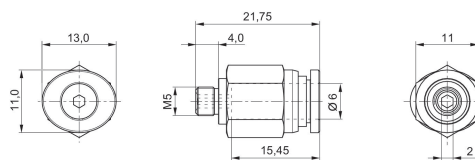

Serie QR1-S-RPN standard

Raccordo diretto
filettatura esterna
Raccordo ad innesto



G	Ø D	Unità di fornitura [Pezzo]	Codice
G 1/8	Ø 4	10	2121004180
G 1/8	Ø 6	10	2121006180
G 1/4	Ø 4	10	2121004140
G 1/4	Ø 6	10	2121006140
G 1/4	Ø 8	10	2121008140
G 3/8	Ø 6	10	R412005000
G 3/8	Ø 8	10	2121008380
G 3/8	Ø 10	10	2121010380
G 1/2	Ø 8	10	R412005001
G 1/2	Ø 10	10	2121010120
G 1/2	Ø 12	10	2121012120

2121004180

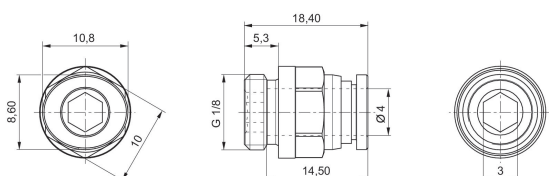

2121006180

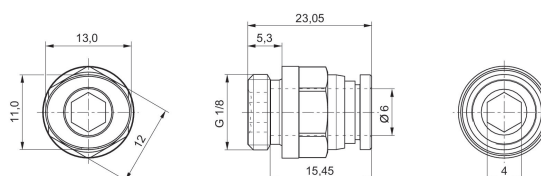

2121004140

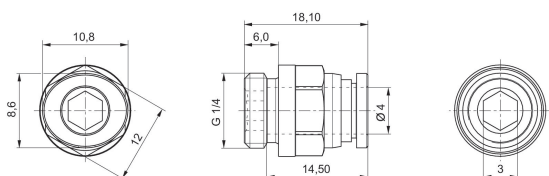

2121006140

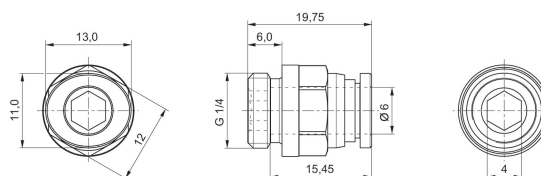

2121008140

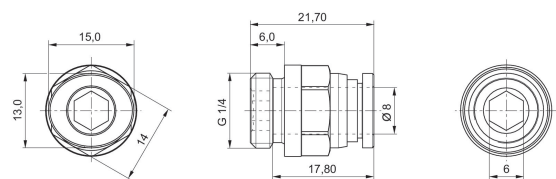

R412005000

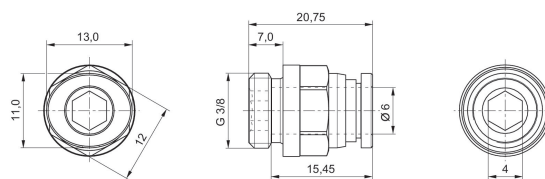

2121008380

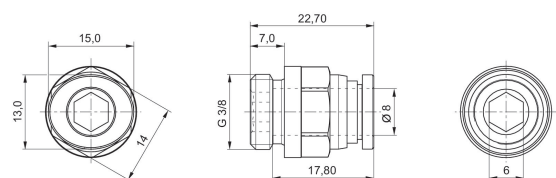

2121010380

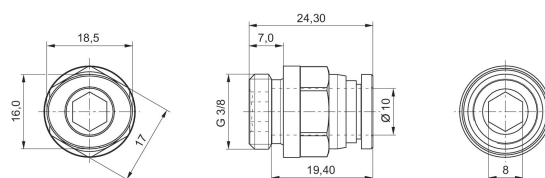

R412005001

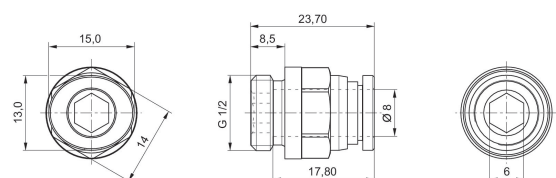

2121010120

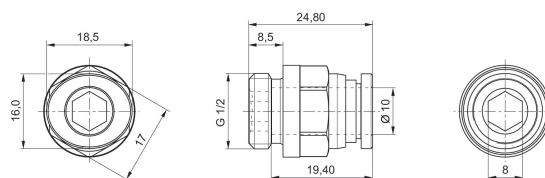

2121012120

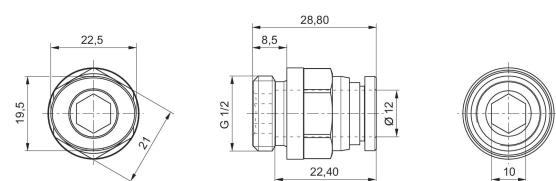

Serie QR1-S-RPN standard

Raccordo diretto
filettatura esterna
Raccordo ad innesto



G	Ø D	Unità di fornitura [Pezzo]	Codice
G 1/8	Ø 8	10	2121008180
G 1/8	Ø 10	10	R412005002
G 1/8	Ø 12	10	R412005003
G 1/4	Ø 10	10	2121010140
G 1/4	Ø 12	10	2121012140
G 3/8	Ø 12	10	2121012380
G 3/8	Ø 14	10	2121014380
G 3/8	Ø16	10	R412005005
G 1/2	Ø 14	10	2121014120
G 1/2	Ø16	10	R412005006

2121008180

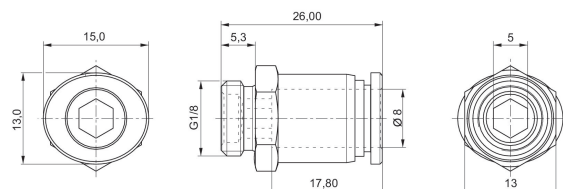

R412005002

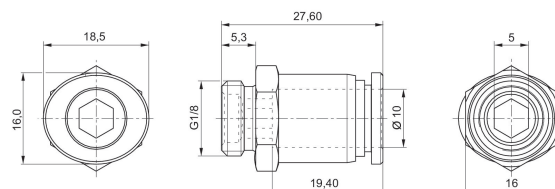

R412005003

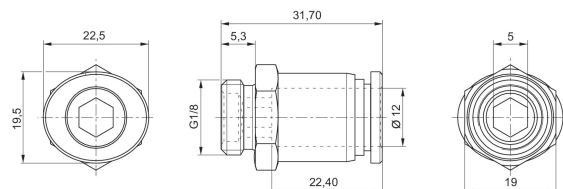

2121010140

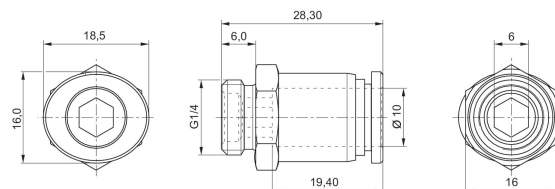

2121012140

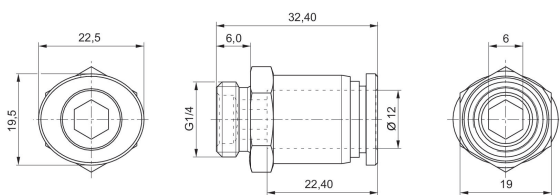

2121012380

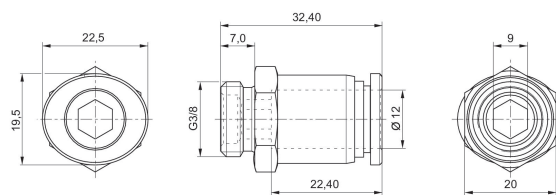

2121014380

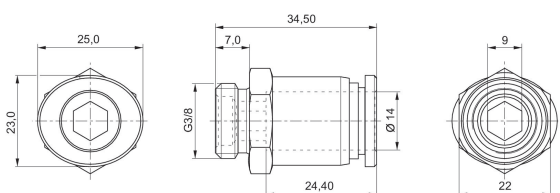

R412005005

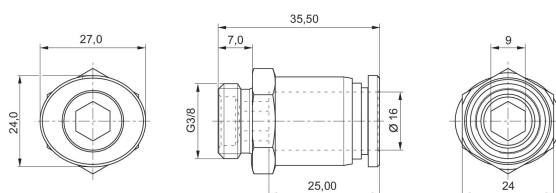

2121014120

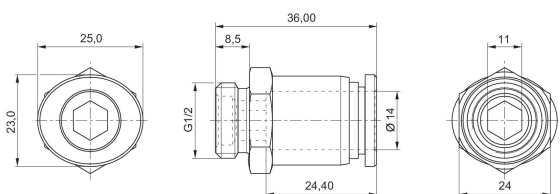

R412005006

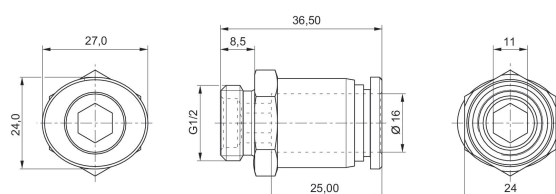

Serie QR1-S-RAS standard

Raccordo passaparete
filettatura esterna
bussola ad innesto



G	Ø D	Unità di fornitura [Pezzo]	Codice
M5	Ø 4	10	2121604050
M5	Ø 6	10	R412005068
G 1/8	Ø 4	10	2121604180
G 1/8	Ø 6	10	2121606180
G 1/8	Ø 8	10	R412005071
G 1/4	Ø 6	10	2121606140
G 1/4	Ø 8	10	2121608140
G 1/4	Ø 10	10	R412005072
G 1/4	Ø 12	10	R412005073
G 3/8	Ø 10	10	2121610380
G 3/8	Ø 12	10	R412005074
G 1/2	Ø 10	10	2121610120
G 1/2	Ø 12	10	2121612120
G 1/2	Ø 14	5	R412005076
G 1/2	Ø 16	5	R412005078

2121604050

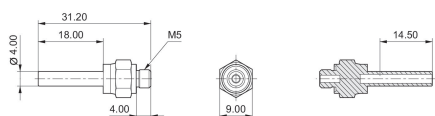

R412005068

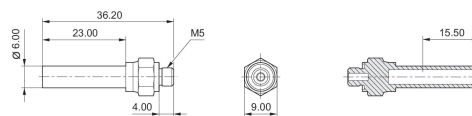

2121604180

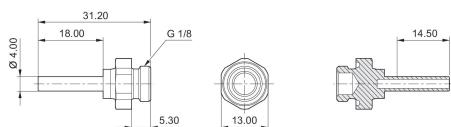

2121606180

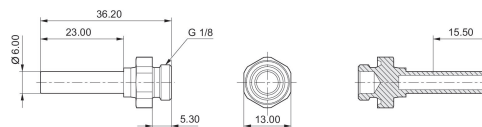

R412005071

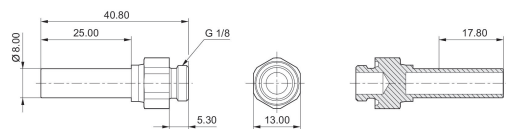

2121606140

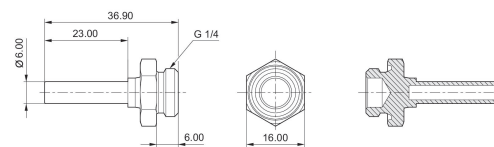

2121608140

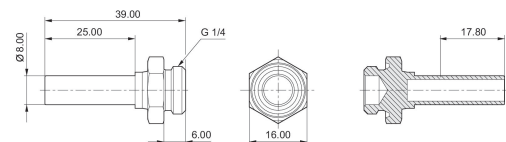

R412005072

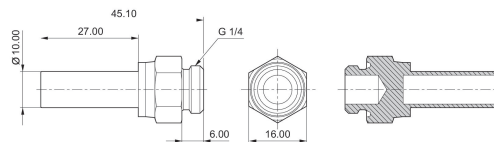

R412005073

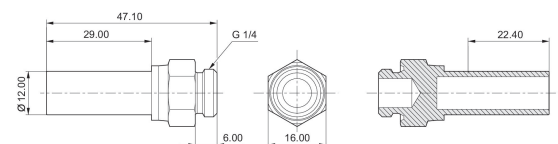

2121610380

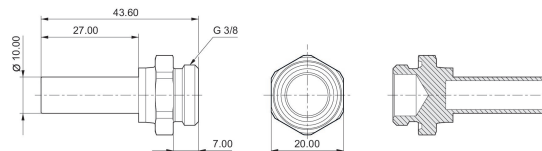

R412005074, 2121610120

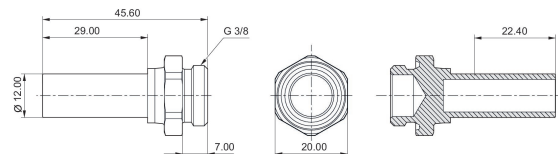

2121612120

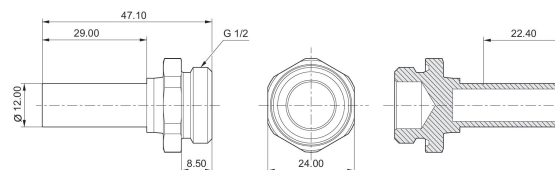

R412005076

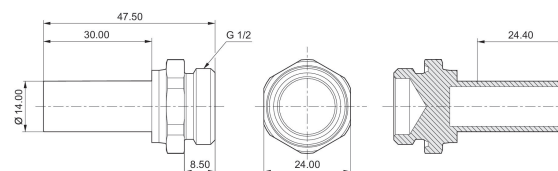

R412005078

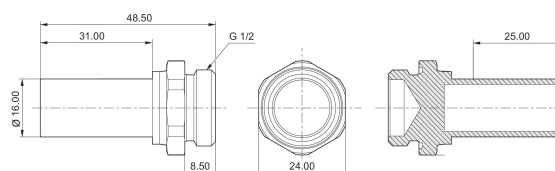

Serie QR1-S-RAI standard

raccordo a vite dritto
Filettatura interna
Raccordo ad innesto

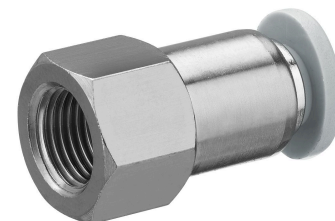

G	Ø D	Unità di fornitura [Pezzo]	Codice
G 1/8	Ø 4	10	2121904180
G 1/8	Ø 6	10	2121906180
G 1/8	Ø 8	10	2121908180
G 1/4	Ø 4	10	R412005085
G 1/4	Ø 6	10	2121906140
G 1/4	Ø 8	10	2121908140
G 1/4	Ø 10	10	R412005089
G 1/4	Ø 12	10	R412005091
G 3/8	Ø 6	10	R412005086
G 3/8	Ø 8	10	R412005087
G 3/8	Ø 10	10	2121910380
G 3/8	Ø 12	10	2121912380
G 1/2	Ø 10	10	R412005090
G 1/2	Ø 12	10	2121912120

2121904180

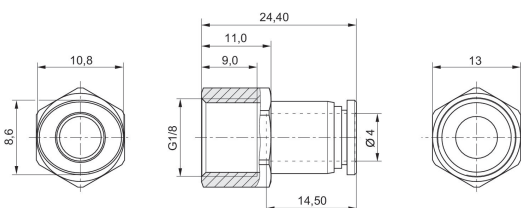

2121906180

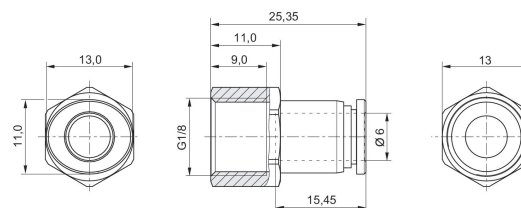

2121908180

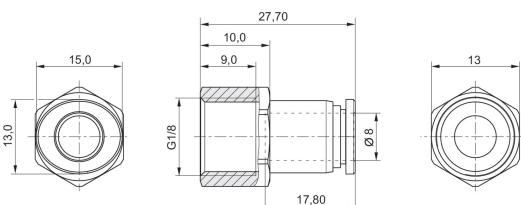

R412005085

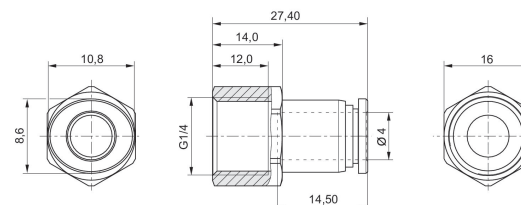

2121906140

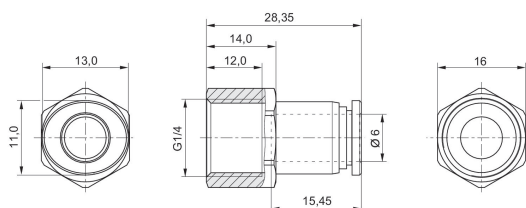

2121908140

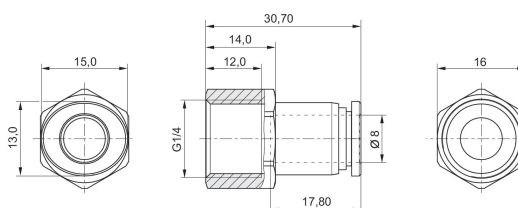

R412005089

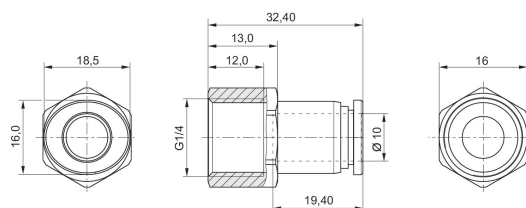

R412005091

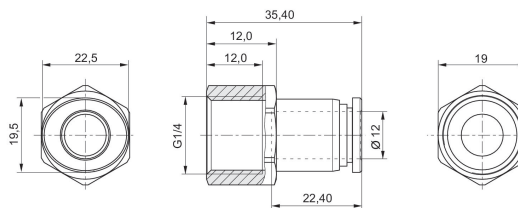

R412005086

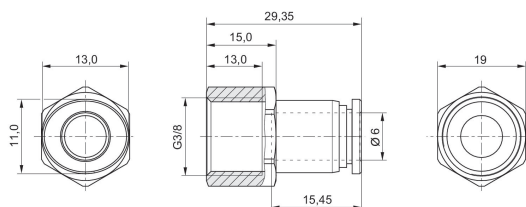

R412005087

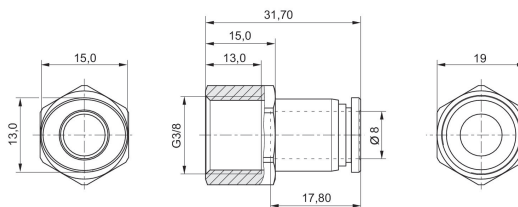

2121910380

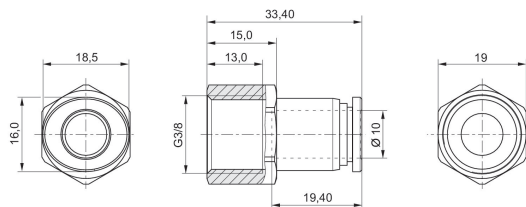

2121912380

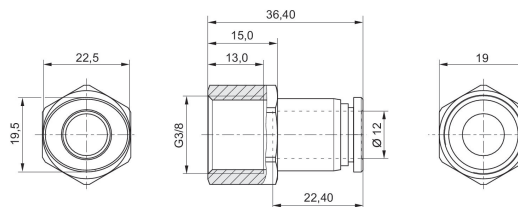

R412005090

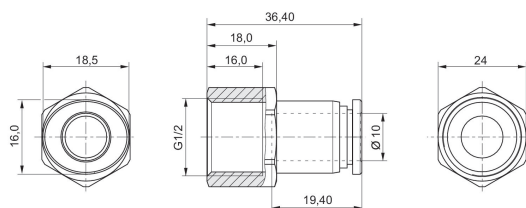

2121912120

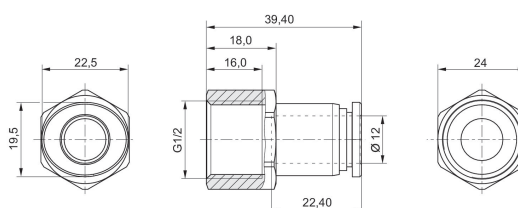

Serie QR1-S-RSI standard

Raccordo passaparete
Filettatura interna
Raccordo ad innesto

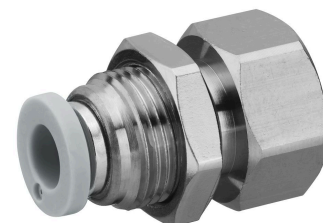

G	Ø D	Unità di fornitura [Pezzo]	Codice
G 1/8	Ø 4	10	2122604180
G 1/8	Ø 6	10	2122606180
G 1/8	Ø 8	10	R412005232
G 1/4	Ø 6	10	2122606140
G 1/4	Ø 8	10	2122608140
G 1/4	Ø 10	10	R412005233
G 3/8	Ø 8	10	R412005231
G 3/8	Ø 10	10	2122610380
G 3/8	Ø 12	10	R412005235
G 1/2	Ø 12	10	2122612120

2122604180

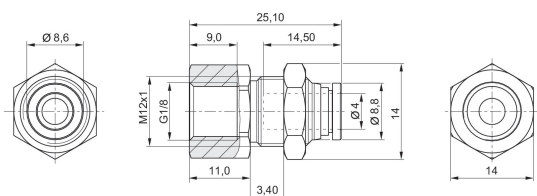

2122606180

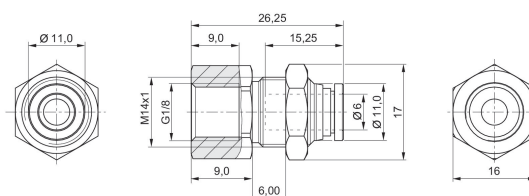

R412005232

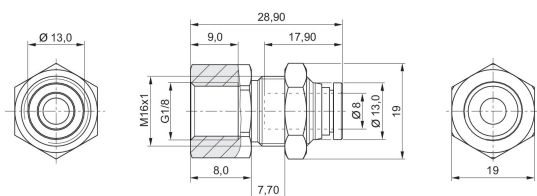

2122606140

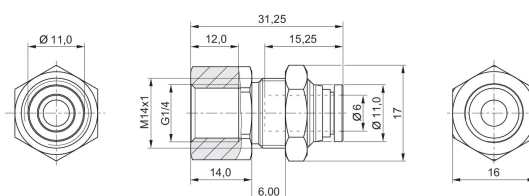

2122608140

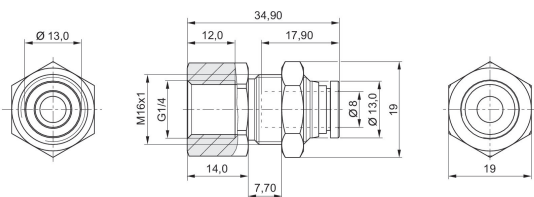

R412005233

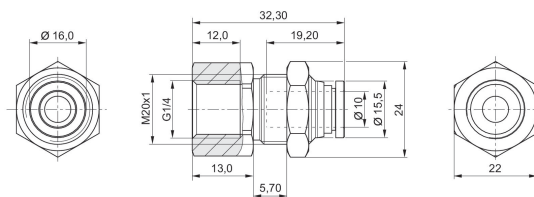

R412005231

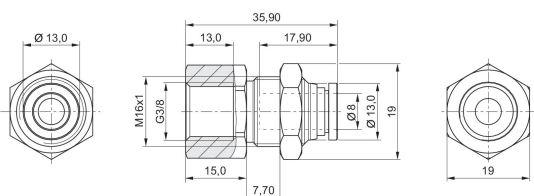

2122610380

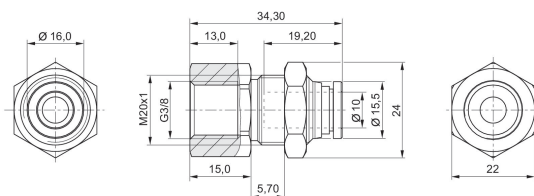

R412005235

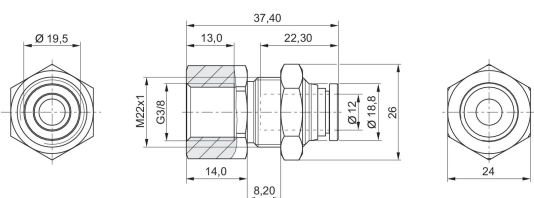

2122612120

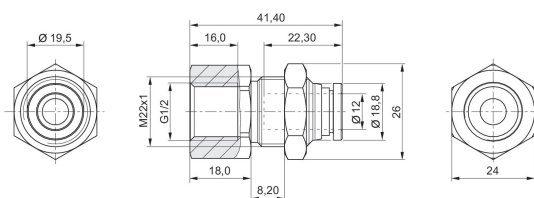

Serie QR1-S-RVT standard

raccordo a gomito
filettatura esterna
Raccordo ad innesto



G	Ø D	Unità di fornitura [Pezzo]	Codice
M5	Ø 4	10	2122004050
M5	Ø 6	10	2122006050

2122004050

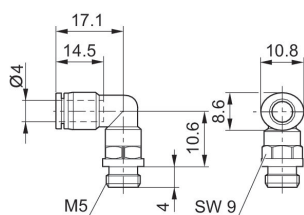

2122006050

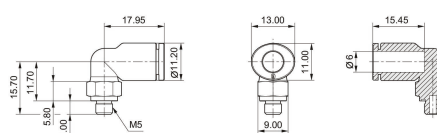

Serie QR1-S-RVT standard

raccordo a gomito
filettatura esterna
Raccordo ad innesto



G	Ø D	Unità di fornitura [Pezzo]	Codice
G 1/8	Ø 4	10	2122004180
G 1/8	Ø 6	10	2122006180
G 1/8	Ø 8	10	2122008180
G 1/8	Ø 10	10	R412005094
G 1/8	Ø 12	10	R412005095
G 1/4	Ø 4	10	2122004140
G 1/4	Ø 6	10	2122006140
G 1/4	Ø 8	10	2122008140
G 1/4	Ø 10	10	2122010140
G 1/4	Ø 12	10	2122012140
G 3/8	Ø 6	10	R412005092
G 3/8	Ø 8	10	2122008380
G 3/8	Ø 10	10	2122010380
G 3/8	Ø 12	10	2122012380
G 3/8	Ø 14	5	2122014380
G 3/8	Ø 16	5	R412005097
G 1/2	Ø 8	10	R412005093
G 1/2	Ø 10	10	2122010120
G 1/2	Ø 12	10	2122012120
G 1/2	Ø 14	5	2122014120
G 1/2	Ø 16	5	R412005098

2122004180

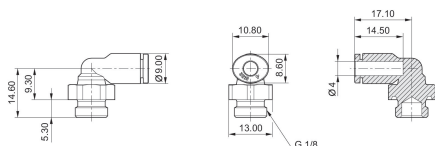

2122006180

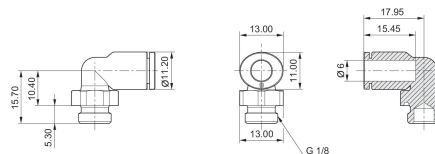

2122008180

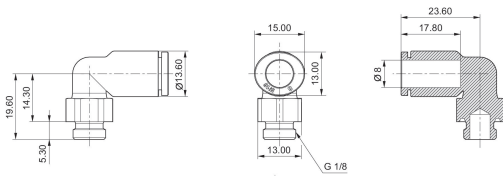

R412005094

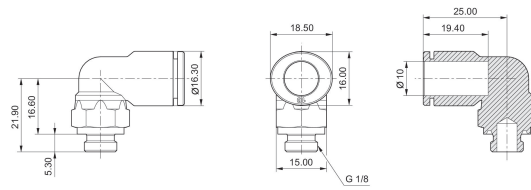

R412005095

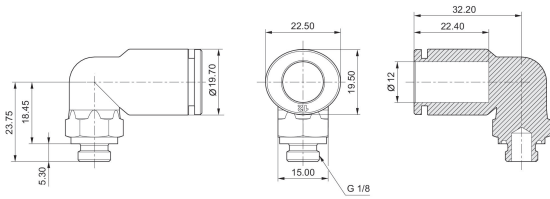

2122004140

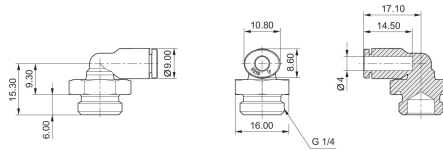

2122006140

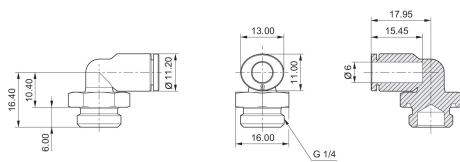

2122008140

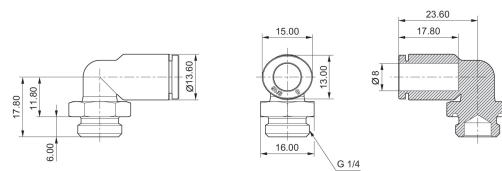

2122010140

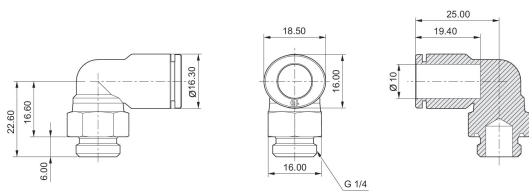

2122012140

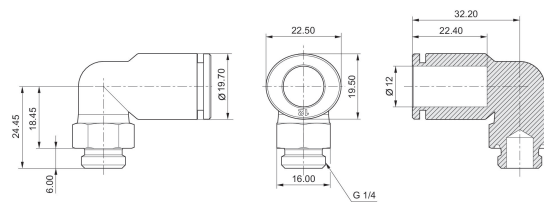

R412005092

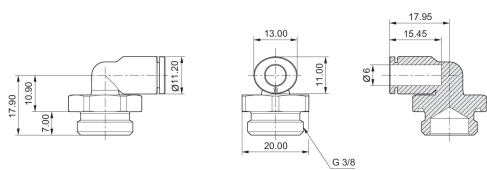

2122008380

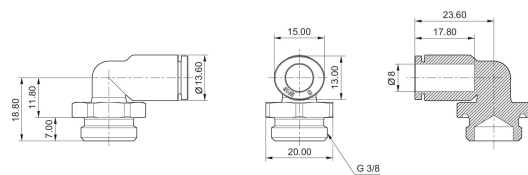

2122010380

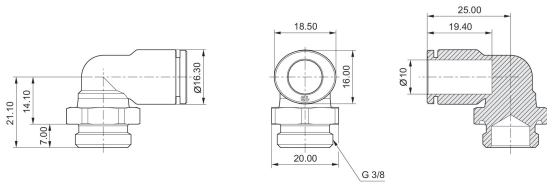

2122012380

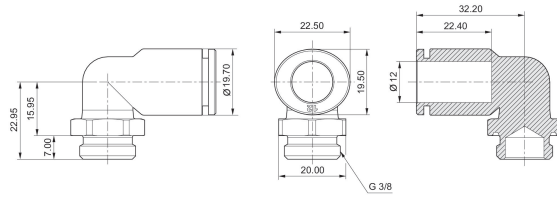

2122014380

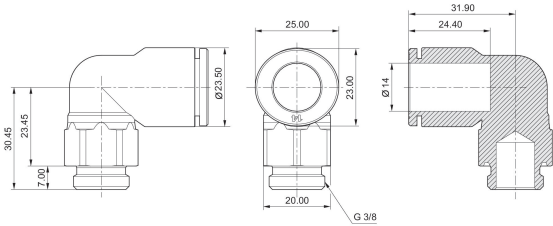

R412005097

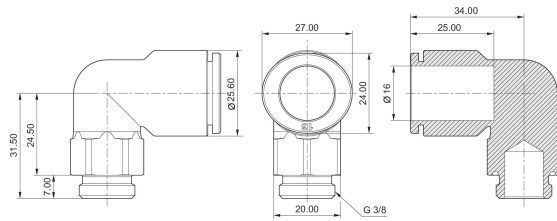

R412005093

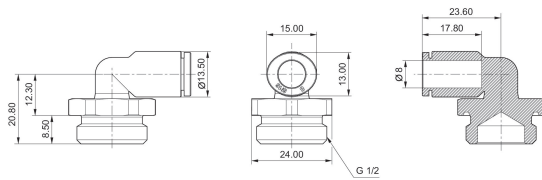

2122010120

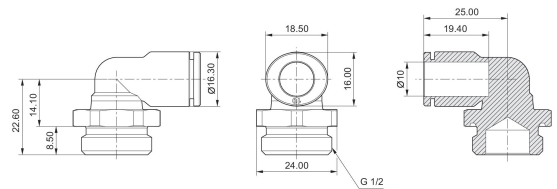

2122012120

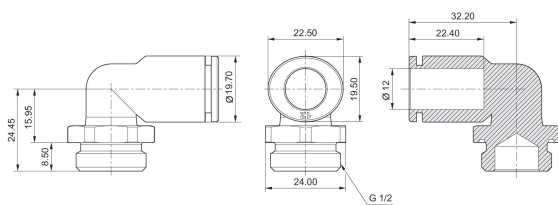

2122014120

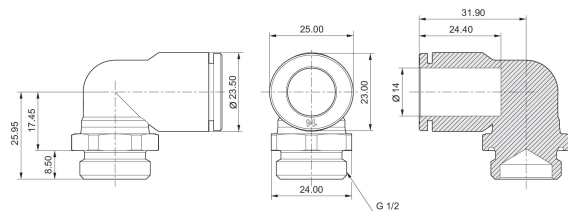

R412005098

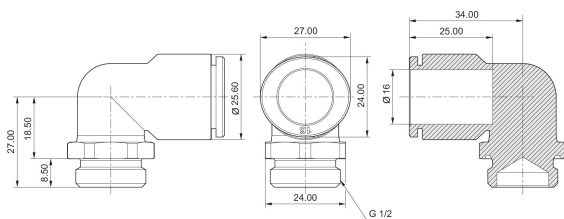

Serie QR1-S-RVL standard

raccordo a gomito lungo
filettatura esterna
Raccordo ad innesto

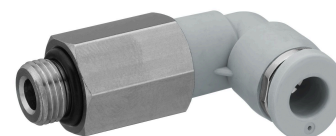

G	Ø D	Unità di fornitura [Pezzo]	Codice
M5	Ø 4	10	2122104050
M5	Ø 6	10	R412005099
G 1/8	Ø 4	10	2122104180
G 1/8	Ø 6	10	2122106180
G 1/8	Ø 8	10	2122108180
G 1/4	Ø 4	10	2122104140
G 1/4	Ø 6	10	2122106140
G 1/4	Ø 8	10	2122108140
G 1/4	Ø 10	10	2122110140
G 1/4	Ø 12	10	R412005103
G 3/8	Ø 8	10	2122108380
G 3/8	Ø 10	10	2122110380
G 3/8	Ø 12	10	R412005104
G 1/2	Ø 12	10	R412005105

2122104050

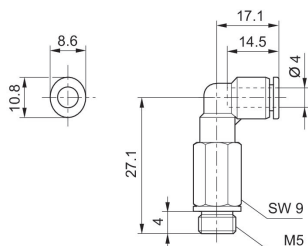

R412005099

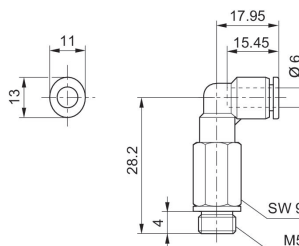

2122104180

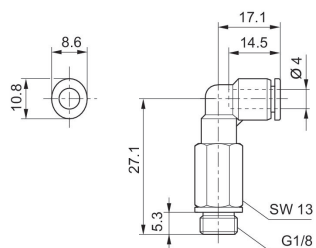

2122106180

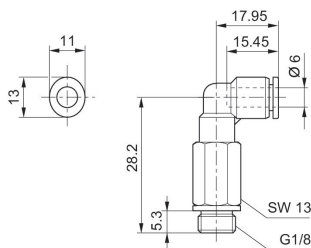

2122108180

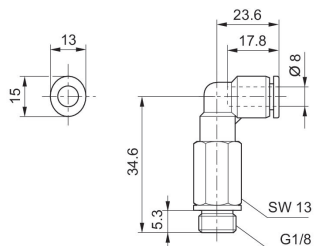

2122104140

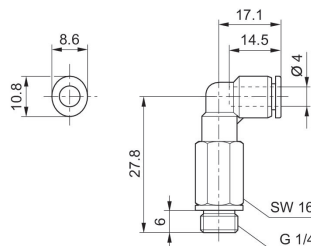

2122106140

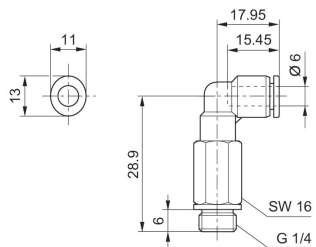

2122108140

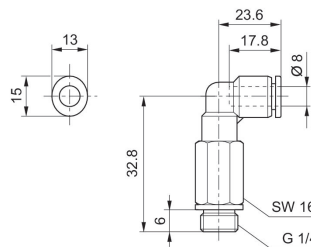

2122110140

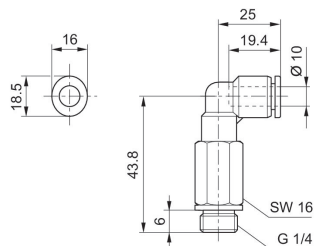

R412005103

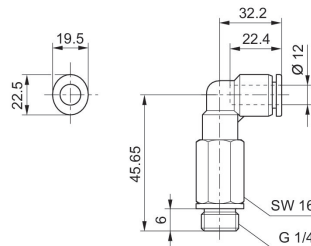

2122108380

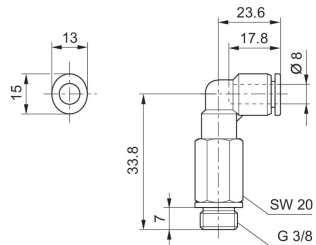

2122110380

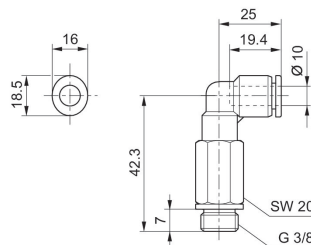

R412005104

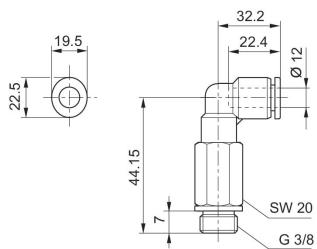

R412005105

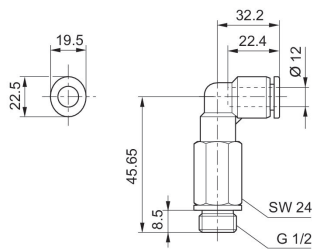

Serie QR1-S-RVI standard

Raccordo a vite a gomito
Filettatura interna
Raccordo ad innesto

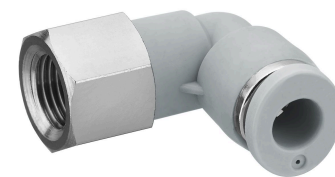

G	Ø D	Unità di fornitura [Pezzo]	Codice
G 1/8	Ø 4	10	R412005129
G 1/8	Ø 6	10	R412005130
G 1/8	Ø 8	10	R412005131
G 1/4	Ø 4	10	R412005132
G 1/4	Ø 6	10	R412005133
G 1/4	Ø 8	10	R412005134
G 1/4	Ø 10	10	R412005135

R412005129

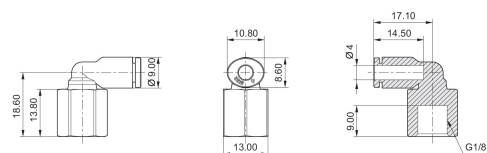

R412005130

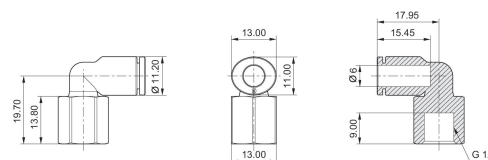

R412005131

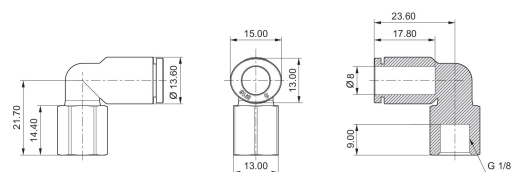

R412005132

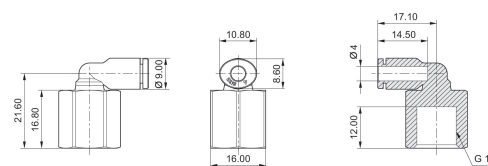

R412005133

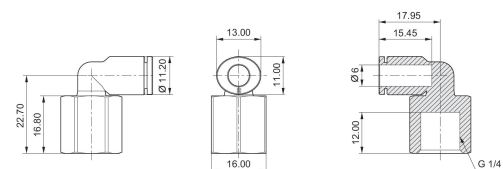

R412005134

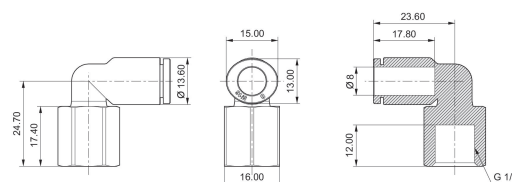

R412005135

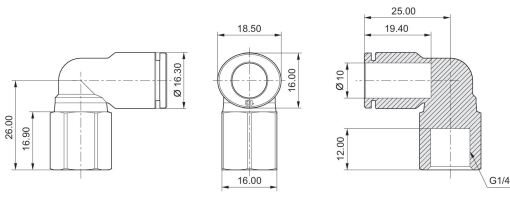

Serie QR1-S-RW1 standard

raccordo oscillante a gomito singolo
filettatura esterna
Raccordo ad innesto

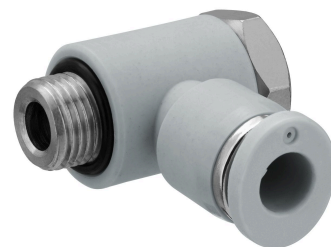

G	Ø D	Unità di fornitura [Pezzo]	Codice
M5	Ø 4	10	R412005236
M5	Ø 6	10	R412005238

R412005236

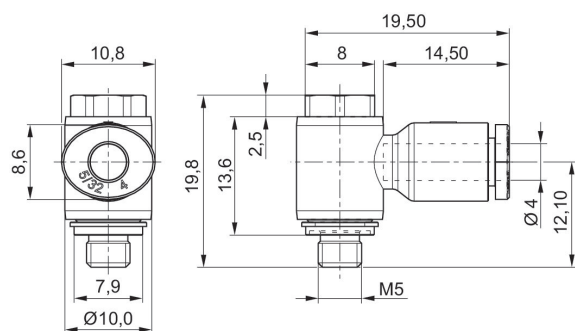

R412005238

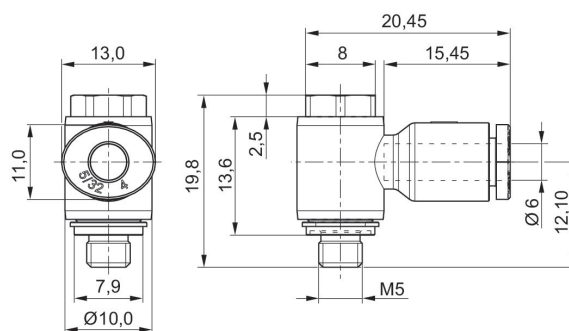

Serie QR1-S-RW1 standard

raccordo oscillante a gomito singolo
filettatura esterna
Raccordo ad innesto

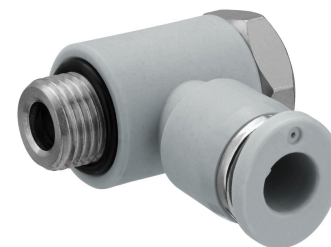

G	Ø D	Unità di fornitura [Pezzo]	Codice
G 1/8	Ø 4	10	R412005237
G 1/8	Ø 6	10	R412005239
G 1/8	Ø 8	10	R412005240
G 1/4	Ø 6	10	R412005241
G 1/4	Ø 8	10	R412005242
G 1/4	Ø 10	10	R412005243
G 3/8	Ø 8	5	R412005244
G 3/8	Ø 10	5	R412005245
G 3/8	Ø 12	5	R412005246

R412005237

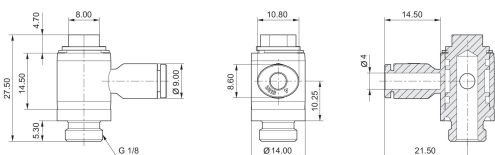

R412005239

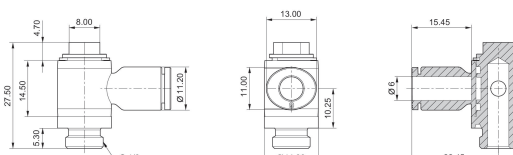

R412005240

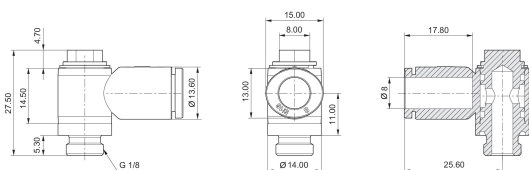

R412005241

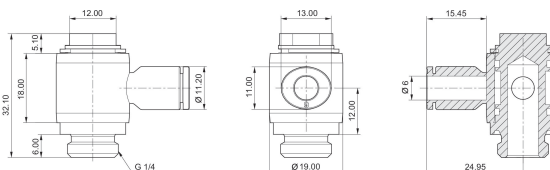

R412005242

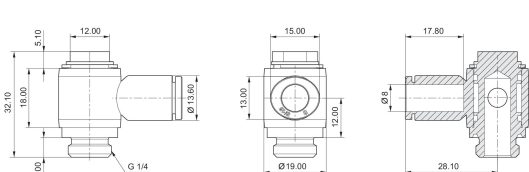

R412005243

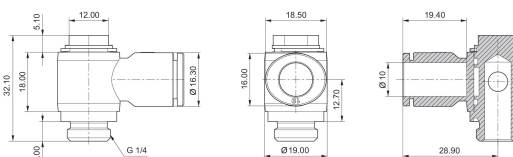

R412005244

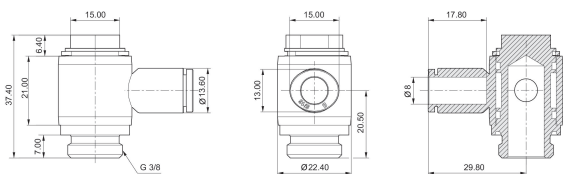

R412005245

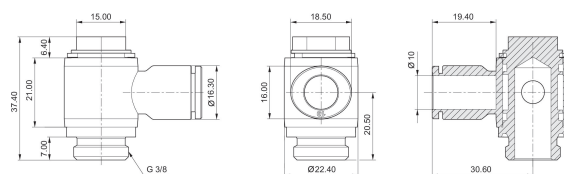

R412005246

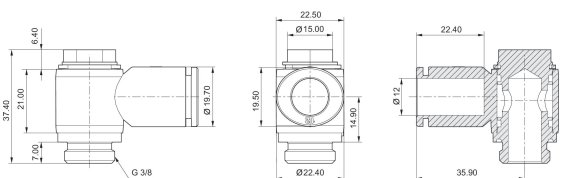

Serie QR1-S-RW2 standard

raccordo oscillante a gomito doppio
filettatura esterna
Raccordo ad innesto



G	Ø D	Unità di fornitura [Pezzo]	Codice
G 1/8	Ø 4	10	R412005141
G 1/8	Ø 6	10	R412005144
G 1/8	Ø 8	10	R412005147
G 1/4	Ø 6	10	R412005145
G 1/4	Ø 8	10	R412005148
G 3/8	Ø 8	10	R412005149
G 3/8	Ø 10	5	R412005152
G 1/2	Ø 12	5	R412005155

R412005141

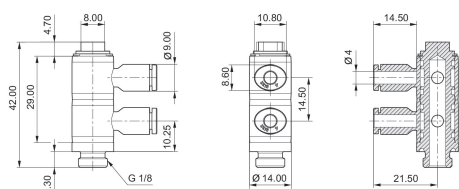

R412005144

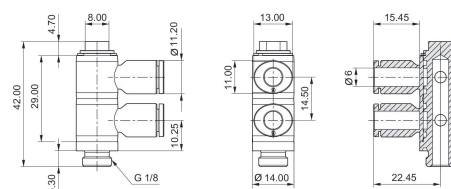

R412005147

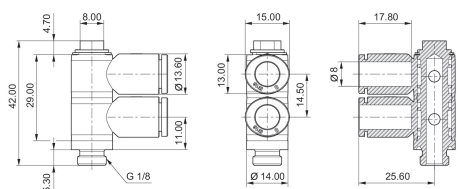

R412005145

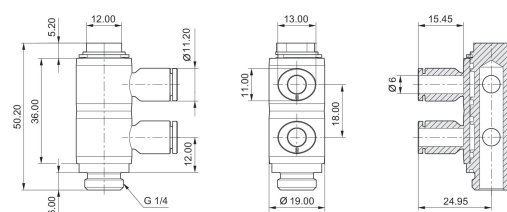

R412005148

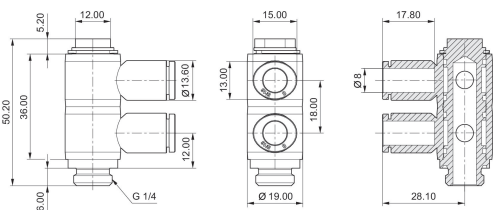

R412005149

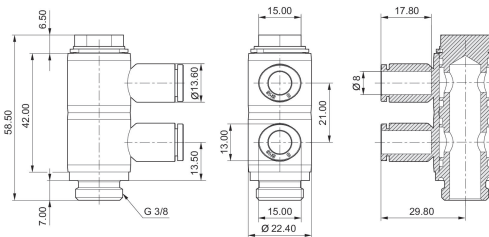

R412005152

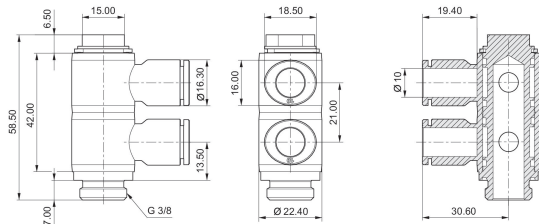

R412005155

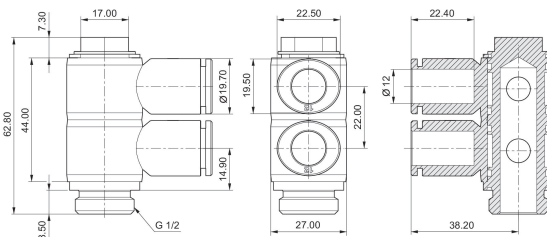

Serie QR1-S-RW6 standard

Raccordo oscillante a gomito a tre vie, doppio filettatura esterna
Raccordo ad innesto



G	Ø D	Unità di fornitura [Pezzo]	Codice
G 1/8	Ø 4	10	R412005186
G 1/8	Ø 6	10	R412005187
G 1/4	Ø 4	10	R412005189
G 1/4	Ø 6	10	R412005190
G 1/4	Ø 8	10	R412005191
G 3/8	Ø 6	10	R412005194
G 3/8	Ø 8	10	R412005195
G 3/8	Ø 10	5	R412005196

R412005186

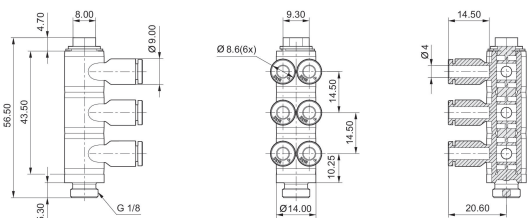

R412005187

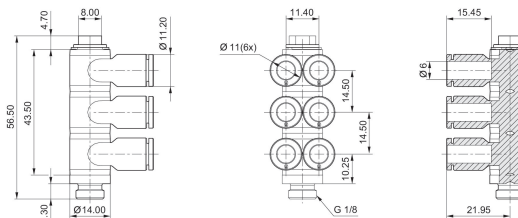

R412005189

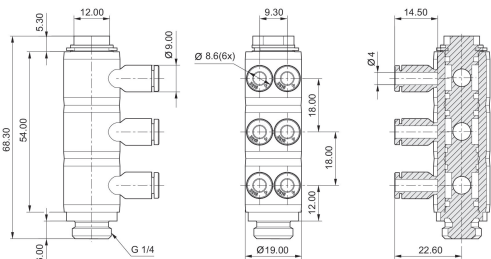

R412005190

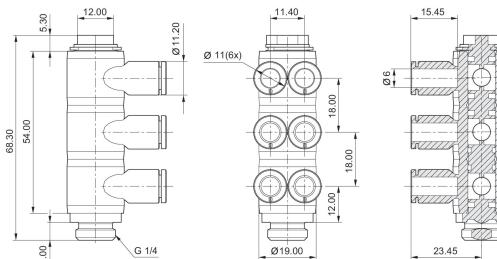

R412005191

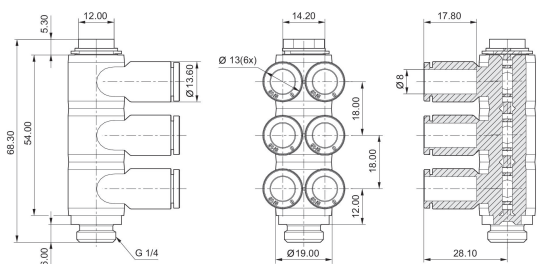

R412005194

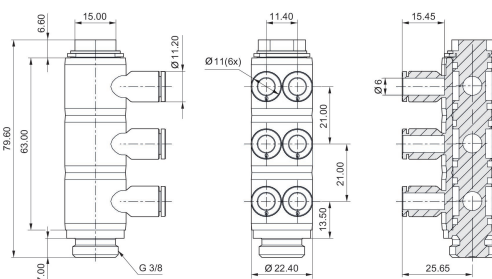

R412005195

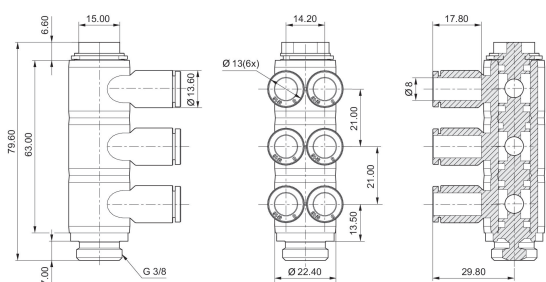

R412005196

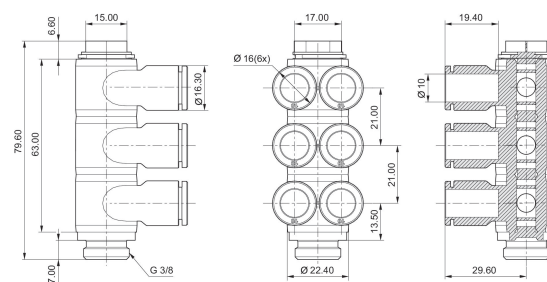

Serie QR1-S-RID standard

Raccordo oscillante a gomito doppio, con filettatura interna
filettatura esterna
Raccordo ad innesto



G	Ø D	Ø	Unità di fornitura [Pezzo]	Codice
M5	Ø 4	M5	10	R412005259
G 1/8	Ø 6	G 1/8	10	R412005260
G 1/4	Ø 8	G 1/4	10	R412005261
G 3/8	Ø 10	G 3/8	5	R412005262

R412005259

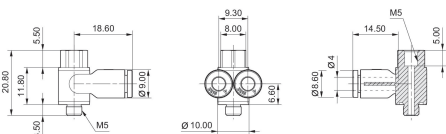

R412005260

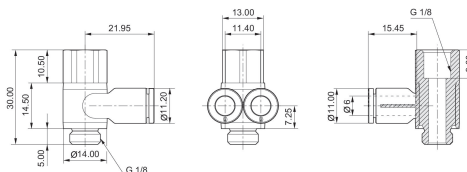

R412005261

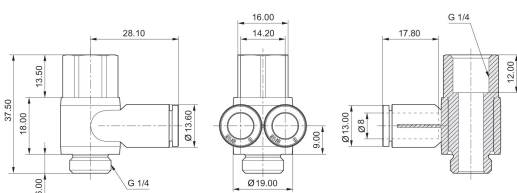

R412005262

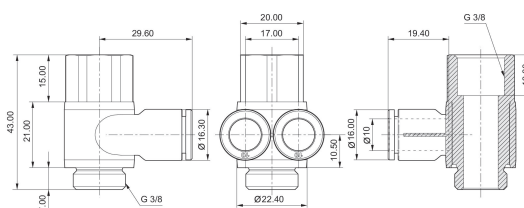

Serie QR1-S-RTT standard

Raccordo a vite a T
filettatura esterna
Raccordo ad innesto

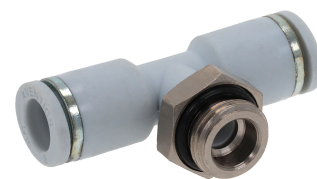

G	Ø D	Unità di fornitura [Pezzo]	Codice
M5	Ø 4	10	2122204050
M5	Ø 6	10	R412005201
G 1/8	Ø 4	10	2122204180
G 1/8	Ø 6	10	2122206180
G 1/8	Ø 8	10	2122208180
G 1/8	Ø 10	10	R412005205
G 1/4	Ø 4	10	2122204140
G 1/4	Ø 6	10	2122206140
G 1/4	Ø 8	10	2122208140
G 1/4	Ø 10	10	2122210140
G 1/4	Ø 12	10	R412005206
G 3/8	Ø 6	10	R412005203
G 3/8	Ø 8	10	2122208380
G 3/8	Ø 10	10	2122210380
G 3/8	Ø 12	10	2122212380
G 3/8	Ø 14	10	2122214380
G 1/2	Ø 10	10	2122210120
G 1/2	Ø 12	5	2122212120
G 1/2	Ø 14	5	2122214120
G 1/2	Ø 16	5	R412005209

2122204050

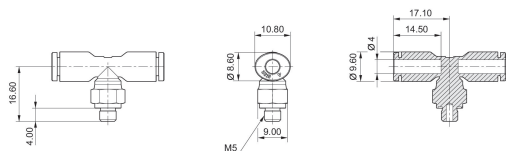

R412005201

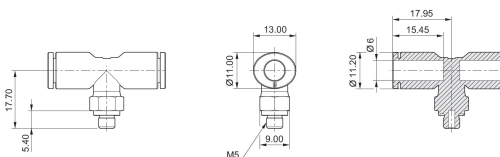

2122204180

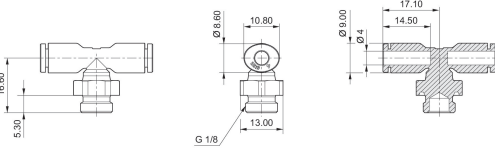

2122206180

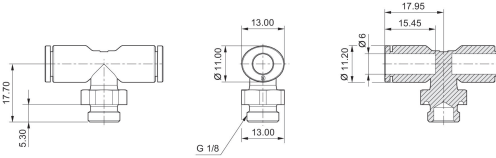

2122208180

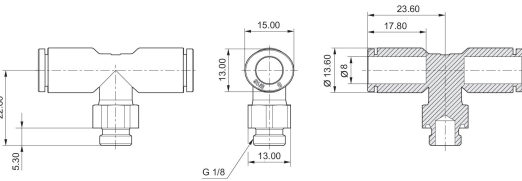

R412005205

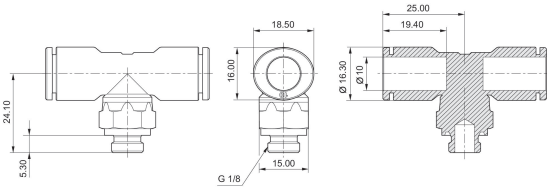

2122204140

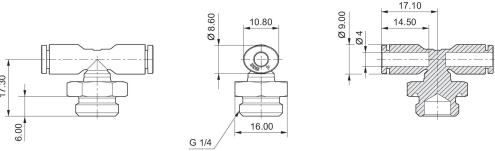

2122206140

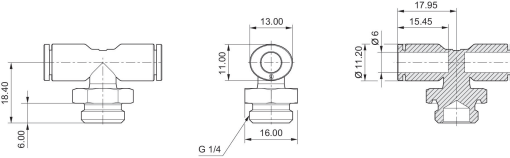

2122208140

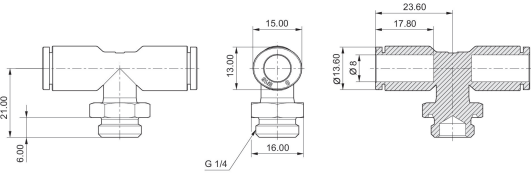

2122210140

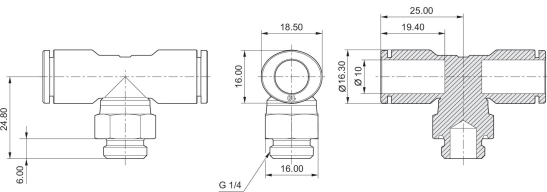

R412005206

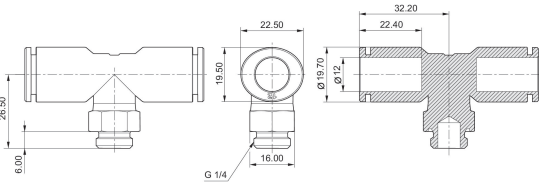

R412005203

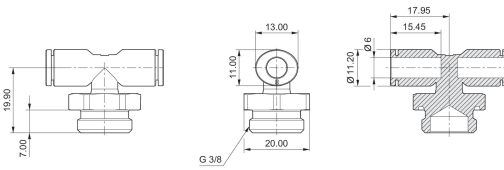

2122208380

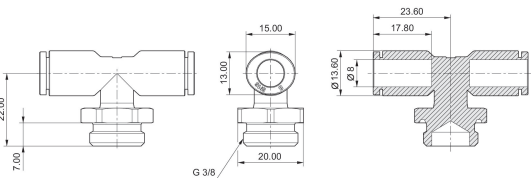

2122210380

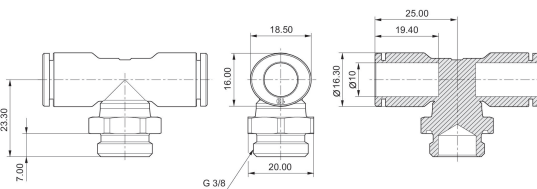

2122212380

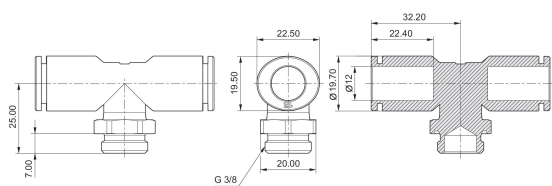

2122214380

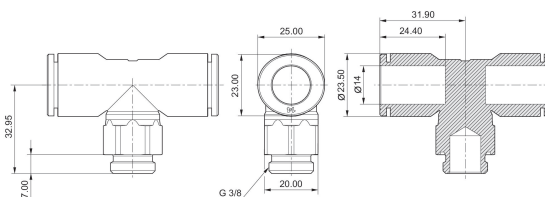

2122210120

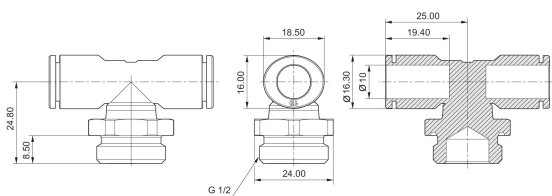

2122212120

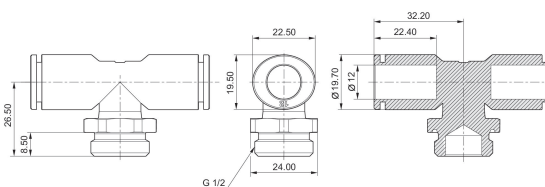

2122214120

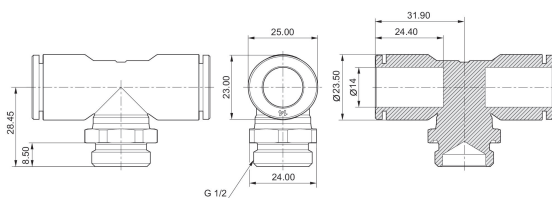

R412005209

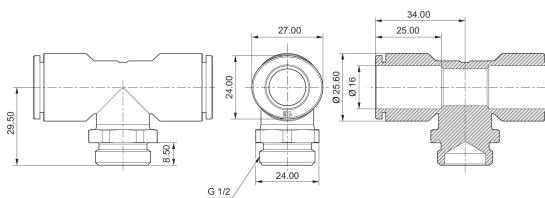

Serie QR1-S-RTS standard

Raccordo orientabile a T
filettatura esterna
Raccordo ad innesto

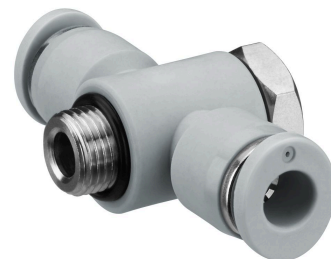

G	Ø D	Unità di fornitura [Pezzo]	Codice
G 1/8	Ø 6	10	R412005292
G 1/8	Ø 8	10	R412005293
G 1/4	Ø 6	10	R412005294
G 1/4	Ø 8	10	R412005295

R412005292

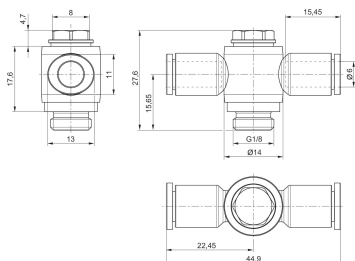

R412005293

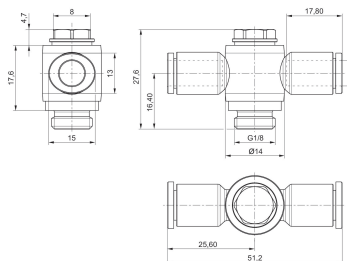

R412005294

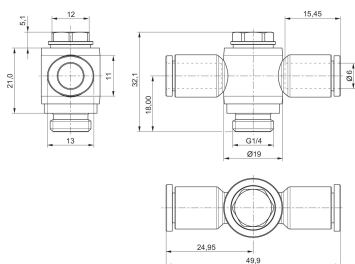

R412005295

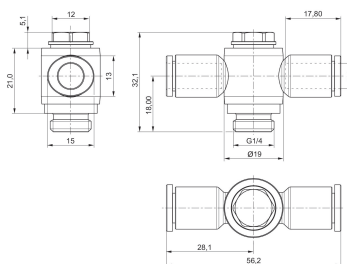

Serie QR1-S-RLT standard

Raccordo a gomito
filettatura esterna
Raccordo ad innesto



G	Ø D	Unità di fornitura [Pezzo]	Codice
M5	Ø 4	10	2122304050
M5	Ø 6	10	R412005212
G 1/8	Ø 4	10	2122304180
G 1/8	Ø 6	10	2122306180
G 1/8	Ø 8	10	R412005214
G 1/4	Ø 4	10	R412005211
G 1/4	Ø 6	10	2122306140
G 1/4	Ø 8	10	2122308140
G 1/4	Ø 10	10	R412005215
G 1/4	Ø 12	5	R412005216
G 3/8	Ø 8	10	2122308380
G 3/8	Ø 10	10	2122310380
G 3/8	Ø 12	5	2122312380
G 1/2	Ø 10	10	2122310120
G 1/2	Ø 12	5	2122312120

2122304050

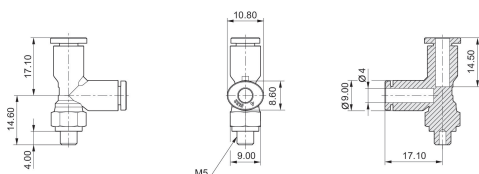

R412005212

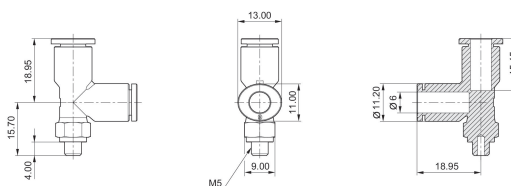

2122304180

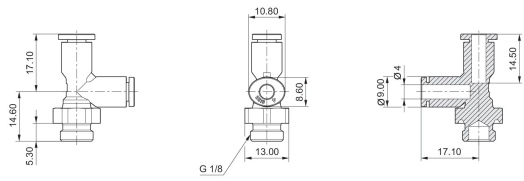

2122306180

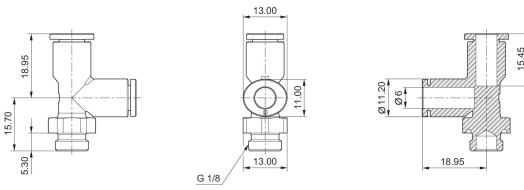

R412005214

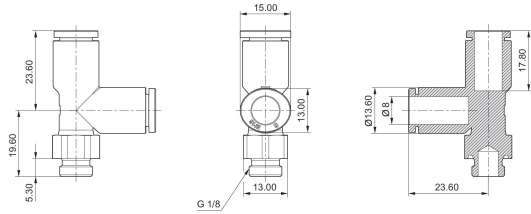

R412005211

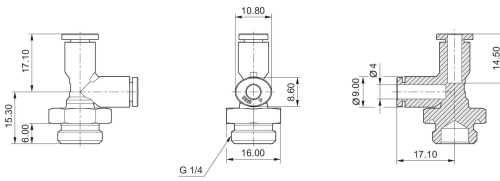

2122306140

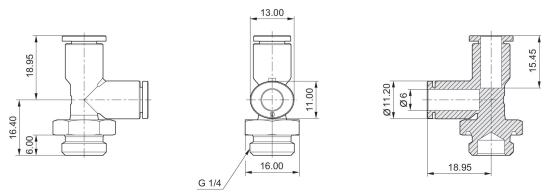

2122308140

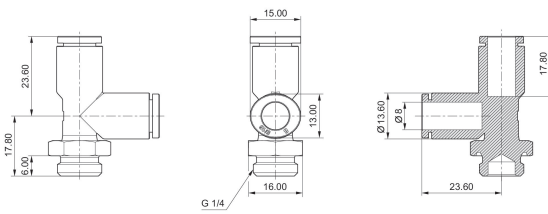

R412005215

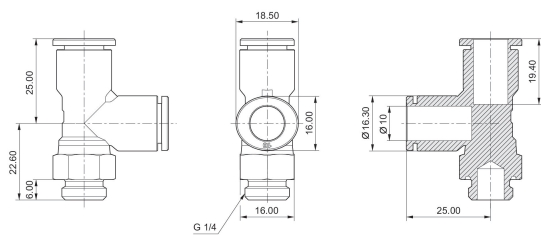

R412005216

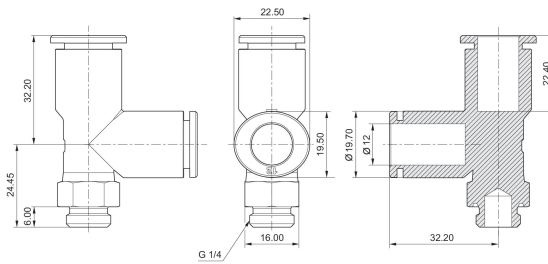

2122308380

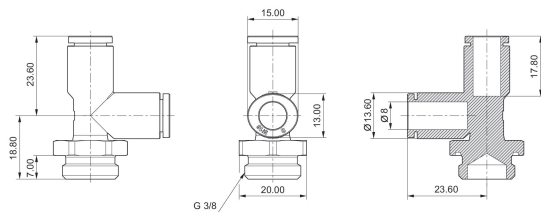

2122310380

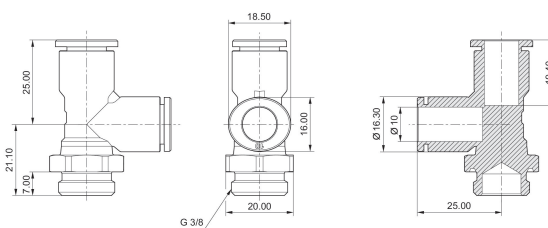

2122312380

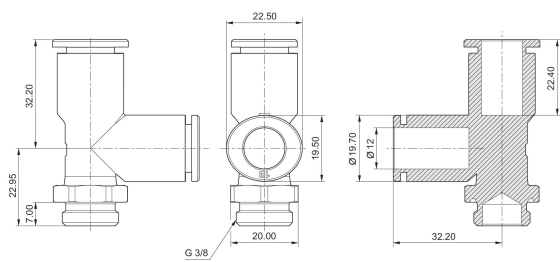

2122310120

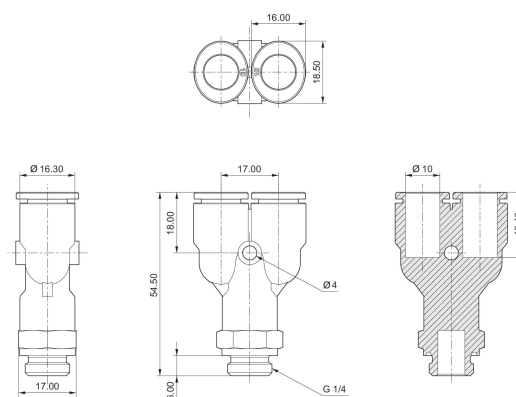

2122312120

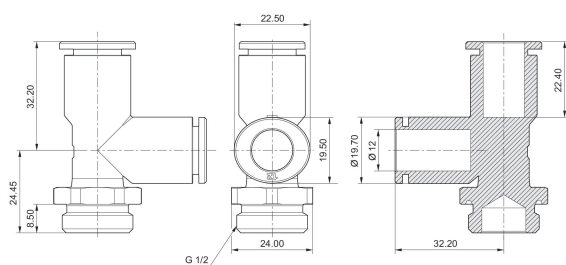

Serie QR1-S-RAY standard

Raccordo a vite Y
filettatura esterna
Raccordo ad innesto



G	Ø D	Unità di fornitura [Pezzo]	Codice
M5	Ø 4	10	2122404050
M5	Ø 6	10	R412005219
G 1/8	Ø 4	10	2122404180
G 1/8	Ø 6	10	2122406180
G 1/8	Ø 8	10	2122408180
G 1/4	Ø 4	10	2122404140
G 1/4	Ø 6	10	2122406140
G 1/4	Ø 8	10	2122408140
G 1/4	Ø 10	10	2122410140
G 3/8	Ø 8	10	R412005221
G 3/8	Ø 10	10	2122410380
G 3/8	Ø 12	10	2122412380
G 1/2	Ø 8	10	R412005222
G 1/2	Ø 10	10	2122410120
G 1/2	Ø 12	10	2122412120

2122404050

R412005219

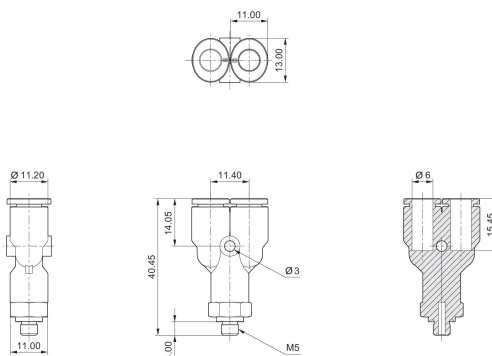
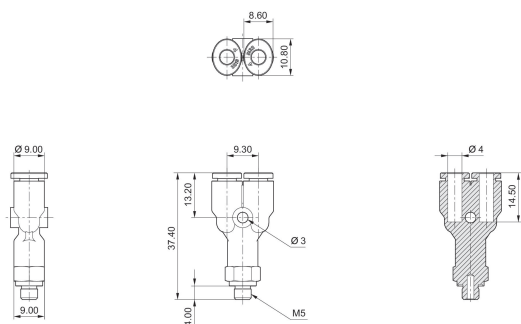

2122404180

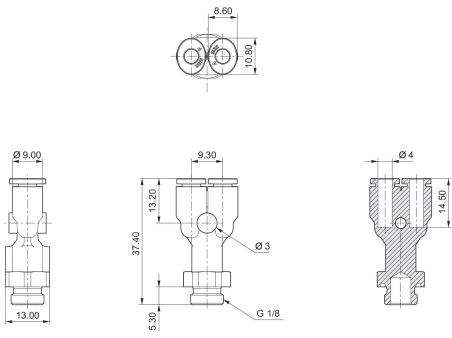

2122406180

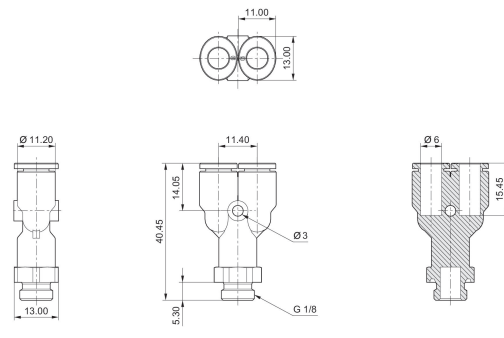

2122408180

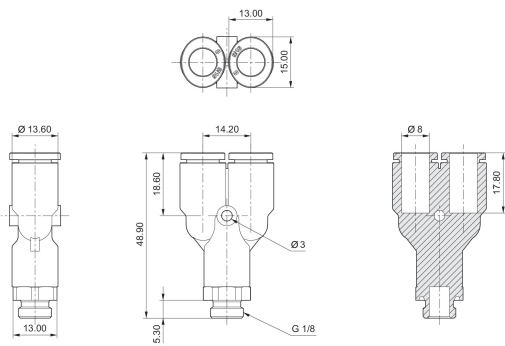

2122404140

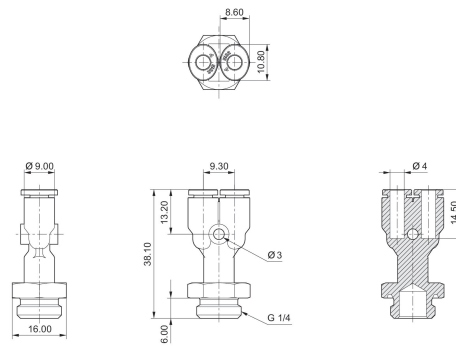

2122406140

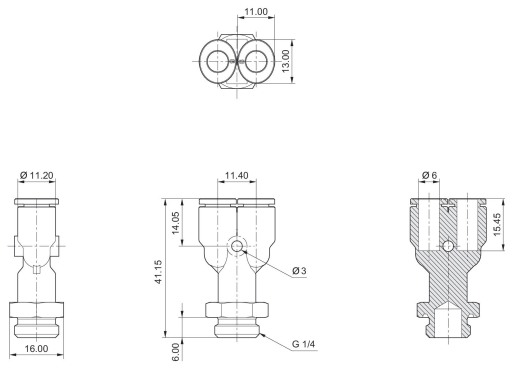

2122408140

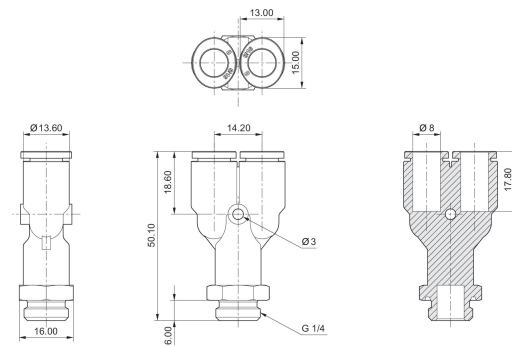

2122410140

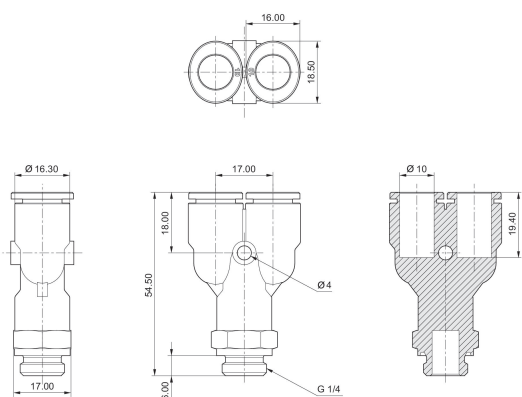

R412005221

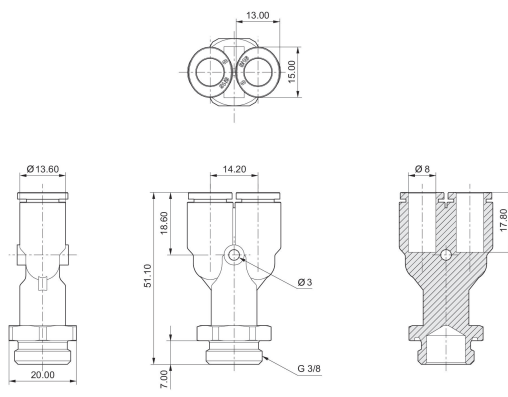

2122410380

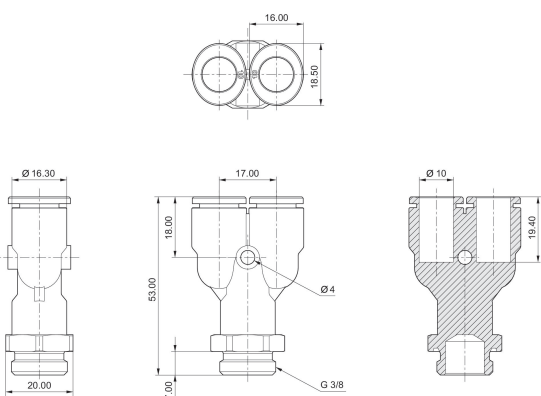

2122412380

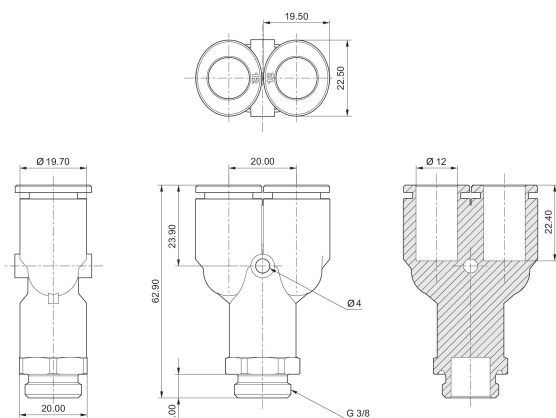

R412005222

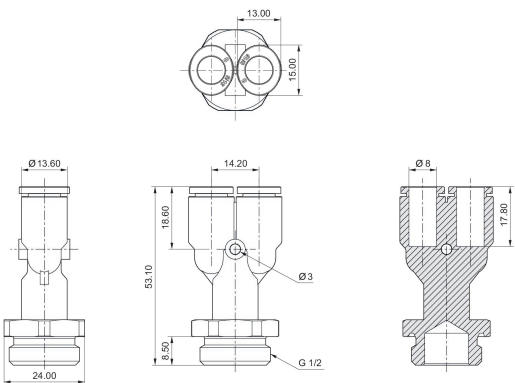

2122410120

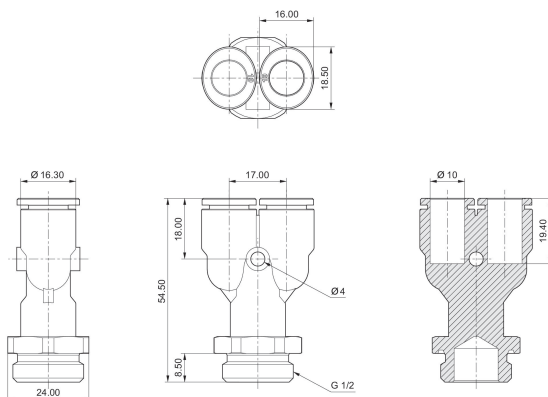

2122412120

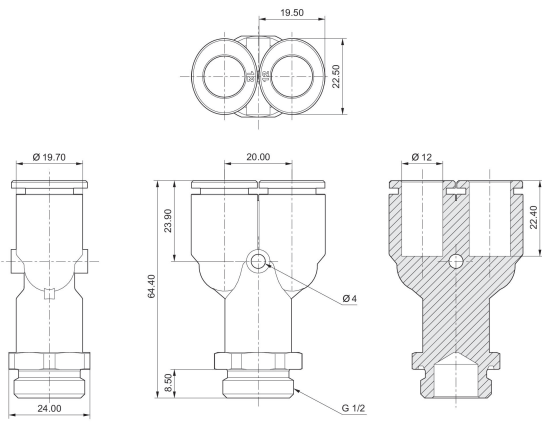

Serie QR1-S-RSK standard

Raccordo ad innesto diritto
Raccordo ad innesto
Raccordo ad innesto

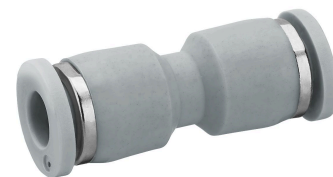

G	Ø D	Unità di fornitura [Pezzo]	Codice
Ø 4	Ø 4	10	2121504000
Ø 6	Ø 6	10	2121506000
Ø 8	Ø 8	10	2121508000
Ø 10	Ø 10	10	2121510000
Ø 12	Ø 12	10	2121512000
Ø 14	Ø 14	5	2121514000
Ø 16	Ø 16	5	R412005059

2121504000

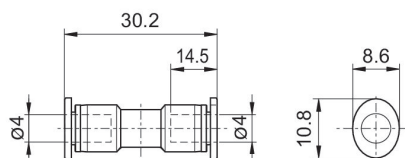

2121506000

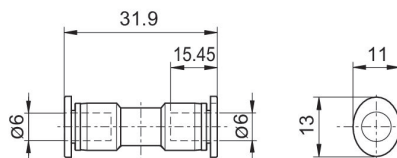

2121508000

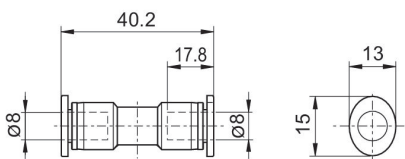

2121510000

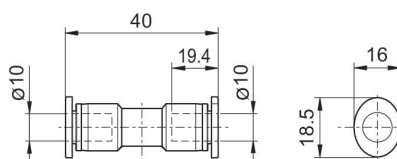

2121512000

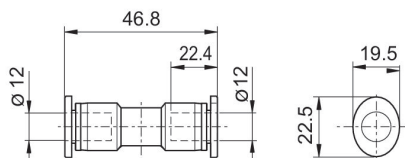

2121514000

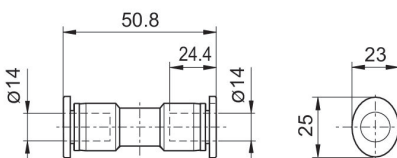

R412005059

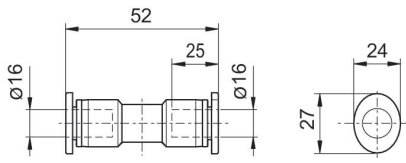

Serie QR1-S-RSR standard

Raccordo ad innesto diritto, riduzione

Raccordo ad innesto

Raccordo ad innesto

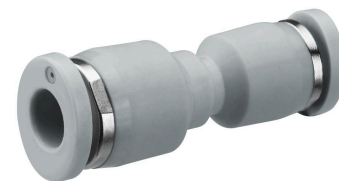

G	Ø D	Unità di fornitura [Pezzo]	Codice
Ø 6	Ø 4	10	R412005060
Ø 8	Ø 4	10	R412005061
Ø 8	Ø 6	10	R412005062
Ø 10	Ø 6	10	R412005063
Ø 10	Ø 8	10	R412005064
Ø 12	Ø 8	10	R412005065
Ø 12	Ø 10	10	R412005066
Ø 16	Ø 12	5	R412005067

R412005060

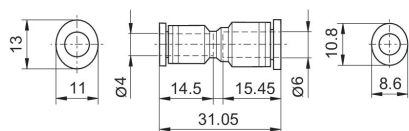

R412005061

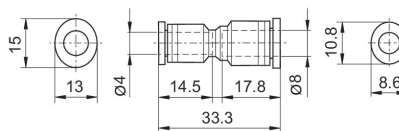

R412005062

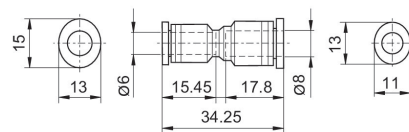

R412005063

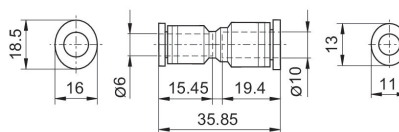

R412005064

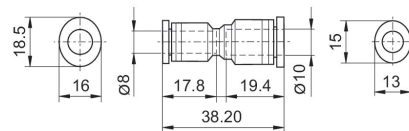

R412005065

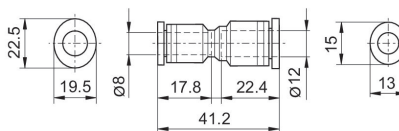

R412005066

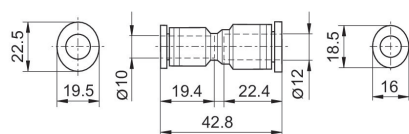

R412005067

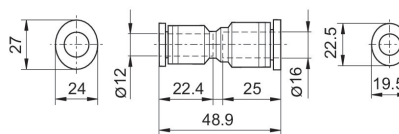

Serie QR1-S-RSM standard

Raccordo passaparete, metallo
Raccordo ad innesto
Raccordo ad innesto



G	Ø D	Unità di fornitura [Pezzo]	Codice
Ø 4	Ø 4	10	2121404000
Ø 6	Ø 6	10	2121406000
Ø 8	Ø 8	10	2121408000
Ø 10	Ø 10	10	2121410000
Ø 12	Ø 12	10	2121412000

2121404000

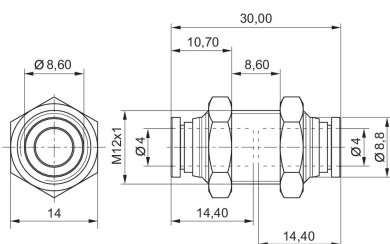

2121406000

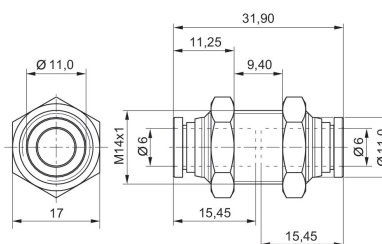

2121408000

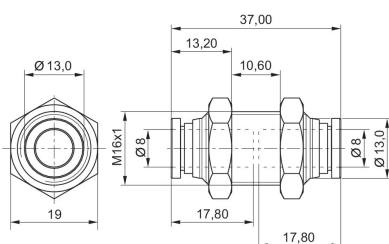

2121410000

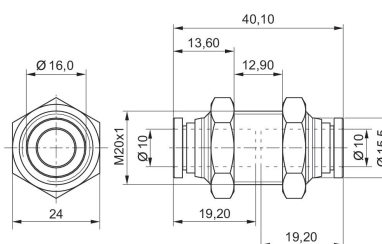

2121412000

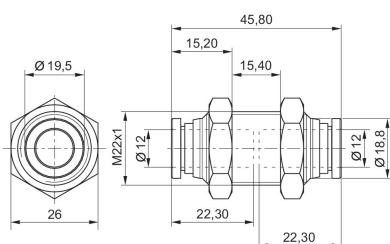

Serie QR1-S-RSC standard

Raccordo passaparete ad innesto, plastica
Raccordo ad innesto
Raccordo ad innesto



G	Ø D	Unità di fornitura [Pezzo]	Codice
Ø 4	Ø 4	10	R412005051
Ø 6	Ø 6	10	R412005052
Ø 8	Ø 8	10	R412005053
Ø 10	Ø 10	10	R412005054
Ø 12	Ø 12	10	R412005055

R412005051

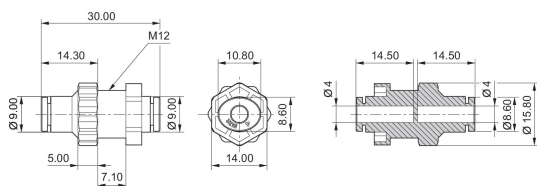

R412005052

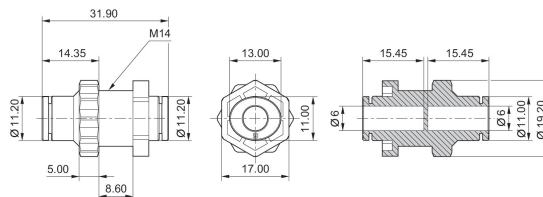

R412005053

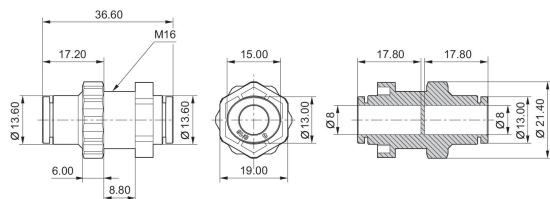

R412005054

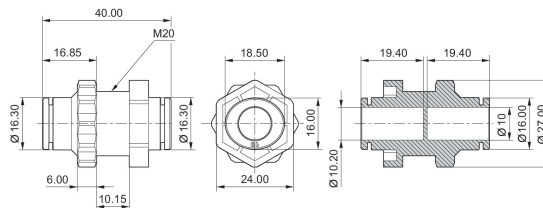

R412005055

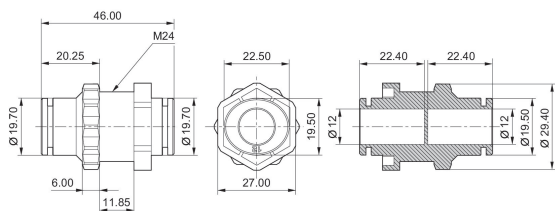

Serie QR1-S-RVW Mini

Raccordo ad innesto a gomito
bussola ad innesto
Raccordo ad innesto



G	Ø D	Unità di fornitura [Pezzo]	Codice
Ø 4	Ø 4	10	R412005046

Dimensioni

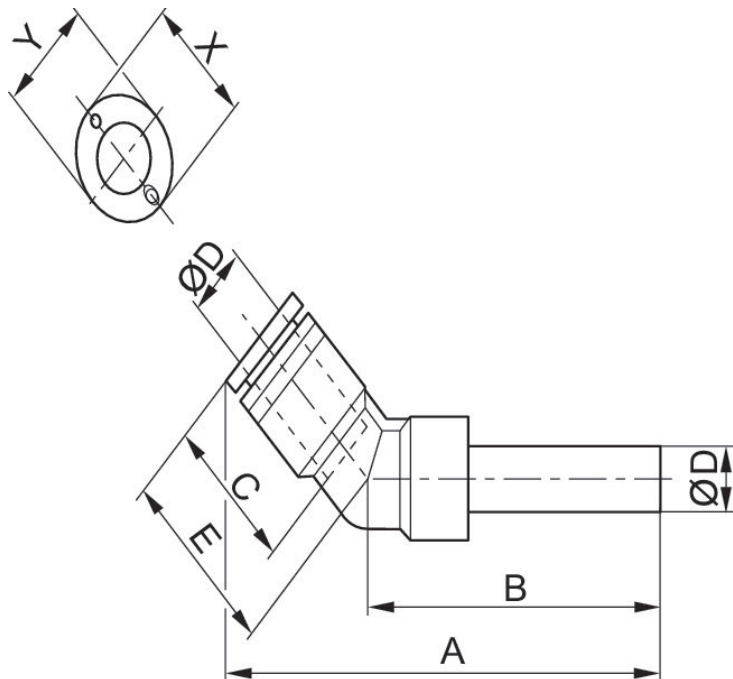

Codice	Raccordo D	Raccordo G	A	B	C	E	X	Y
R412005046	Ø 4	Ø 4	56,36	43,6	16	18.1	12	10

Serie QR1-S-RVK standard

Raccordo ad innesto a gomito

Raccordo ad innesto

Raccordo ad innesto

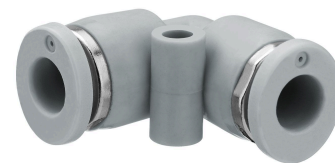

G	Ø D	Unità di fornitura [Pezzo]	Codice
Ø 4	Ø 4	10	2121204000
Ø 6	Ø 6	10	2121206000
Ø 8	Ø 8	10	2121208000
Ø 10	Ø 10	10	2121210000
Ø 12	Ø 12	10	2121212000
Ø 14	Ø 14	5	2121214000
Ø 16	Ø 16	5	R412005033

2121204000

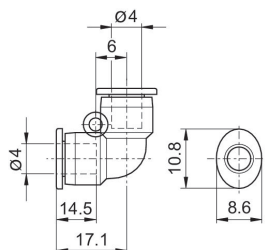

2121206000

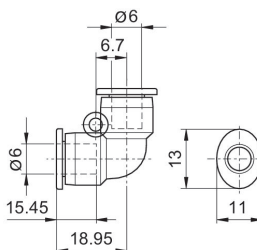

2121208000

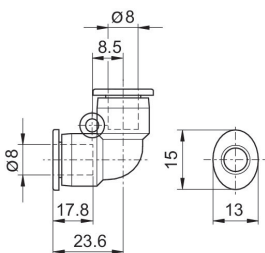

2121210000

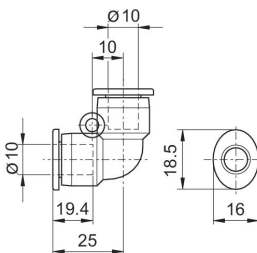

2121212000

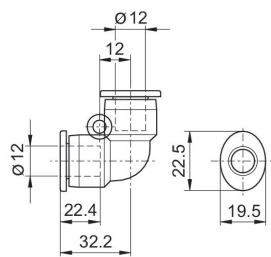

2121214000

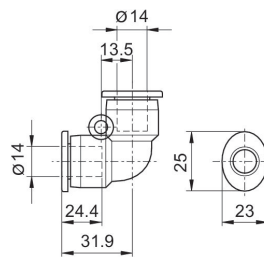

R412005033

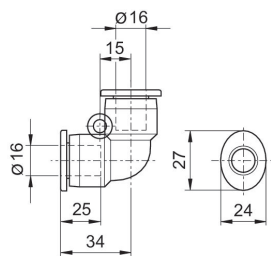

Serie QR1-S-RVS standard

Raccordo passaparete ad innesto a gomito
Raccordo ad innesto
Raccordo ad innesto



G	Ø D	Unità di fornitura [Pezzo]	Codice
Ø 4	Ø 4	10	R412005056
Ø 6	Ø 6	10	R412005057
Ø 8	Ø 8	10	R412005375
Ø 10	Ø 10	10	R412005376

R412005056

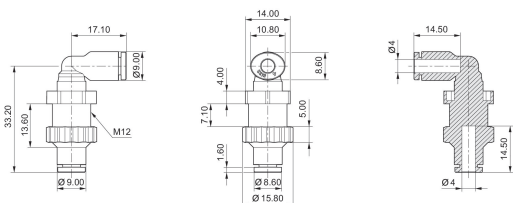

R412005057

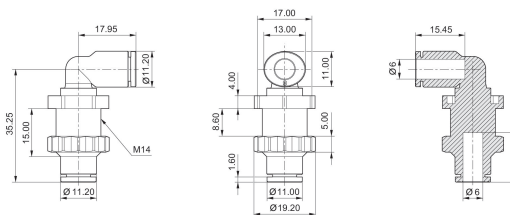

R412005375

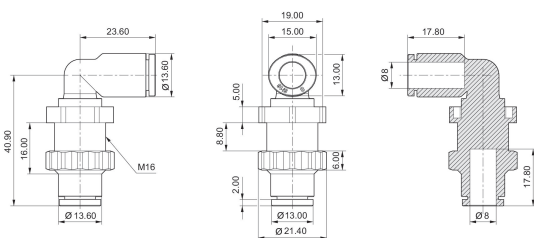

R412005376

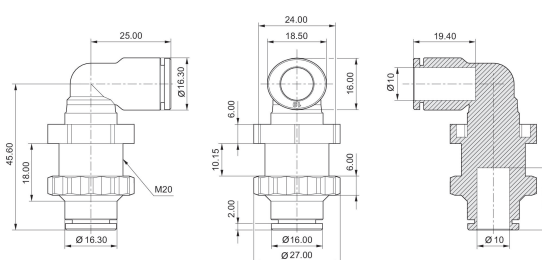

Serie QR1-S-RMT standard

Raccordo ad innesto, a 3 vie, riduttore
Raccordo ad innesto
Raccordo ad innesto



G	Ø D	Unità di fornitura [Pezzo]	Codice
Ø 6	Ø 4	10	R412005346
Ø 8	Ø 4	10	R412005347
Ø 8	Ø 6	10	R412005348
Ø 10	Ø 6	10	R412005349
Ø 10	Ø 8	10	R412005350

R412005346

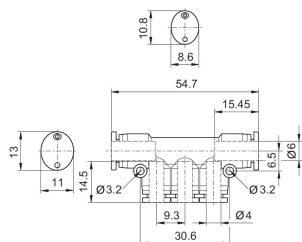

R412005347

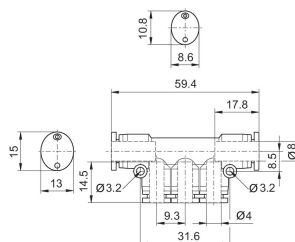

R412005348

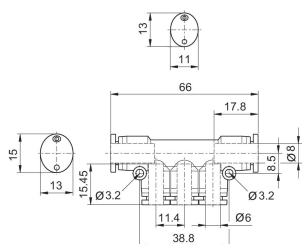

R412005349

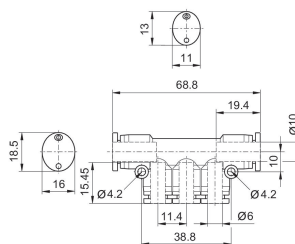

R412005350

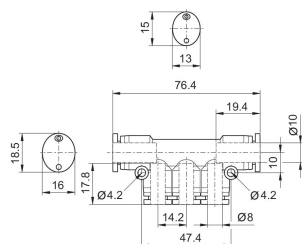

Serie QR1-S-RTK standard

Raccordo ad innesto a T
Raccordo ad innesto
Raccordo ad innesto

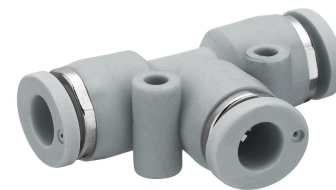

G	Ø D	Unità di fornitura [Pezzo]	Codice
Ø 4	Ø 4	10	2121104000
Ø 6	Ø 6	10	2121106000
Ø 8	Ø 8	10	2121108000
Ø 10	Ø 10	10	2121110000
Ø 12	Ø 12	10	2121112000
Ø 14	Ø 14	5	2121114000
Ø 16	Ø 16	5	R412005025

2121104000

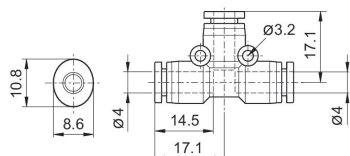

2121106000

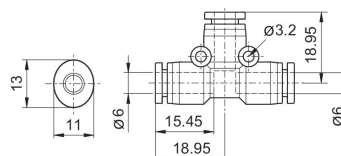

2121108000

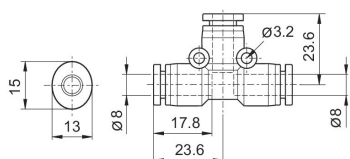

2121110000

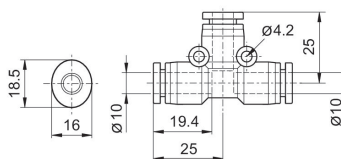

2121112000

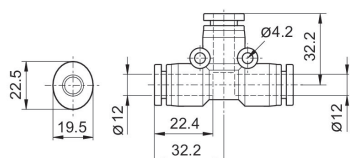

2121114000

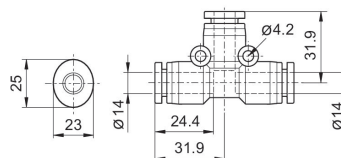

R412005025

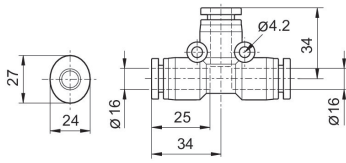

Serie QR1-S-RTR standard

Raccordo ad innesto a T, riduttore
Raccordo ad innesto
Raccordo ad innesto



G	Ø D	Unità di fornitura [Pezzo]	Codice
Ø 6	Ø 4	10	R412005026
Ø 8	Ø 4	10	R412005027
Ø 8	Ø 6	10	R412005028
Ø 10	Ø 6	10	R412005029
Ø 10	M8	10	R412005030
Ø 12	Ø 8	10	R412005031
Ø 12	Ø 10	10	R412005032

R412005026

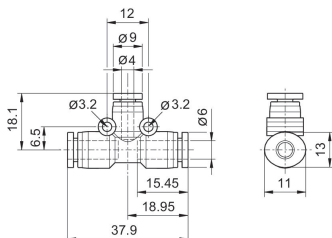

R412005027

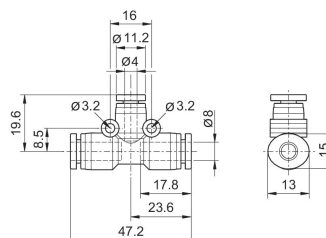

R412005028

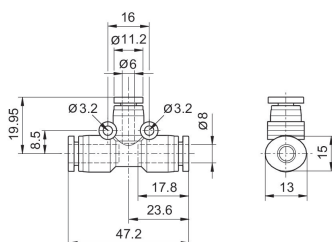

R412005029

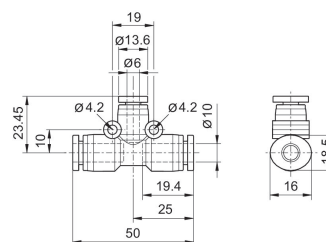

R412005030

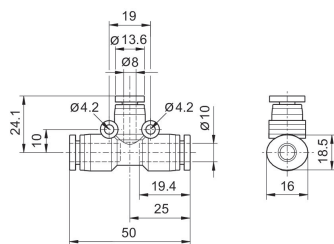

R412005031

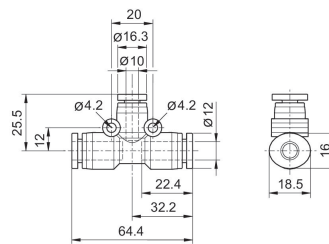

R412005032

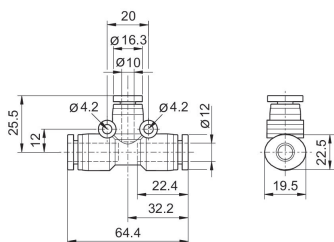

Serie QR1-S-RYK standard

Raccordo ad innesto ad Y
Raccordo ad innesto
Raccordo ad innesto

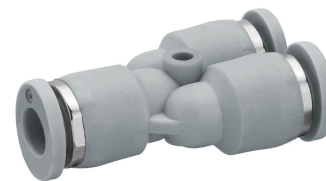

G	Ø D	Unità di fornitura [Pezzo]	Codice
Ø 4	Ø 4	10	2121804000
Ø 6	Ø 6	10	2121806000
Ø 8	Ø 8	10	2121808000
Ø 10	Ø 10	10	2121810000
Ø 12	Ø 12	10	2121812000

2121804000

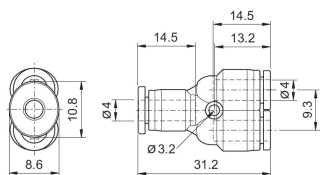

2121806000

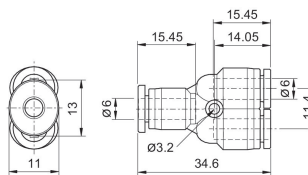

2121808000

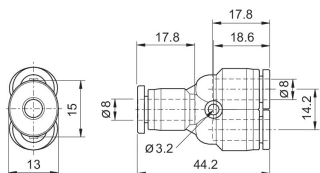

2121810000

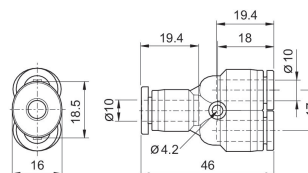

2121812000

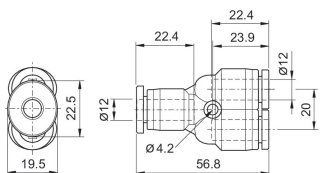

Serie QR1-S-RYR standard

Raccordo ad innesto ad Y, riduttore
Raccordo ad innesto
Raccordo ad innesto



G	Ø D	Unità di fornitura [Pezzo]	Codice
Ø 6	Ø 4	10	2121806040
Ø 8	Ø 4	10	R412005081
Ø 8	Ø 6	10	2121808060
Ø 10	Ø 6	10	R412005082
Ø 10	Ø 8	10	2121810080
Ø 12	Ø 8	10	R412005083
Ø 12	Ø 10	10	R412005080

2121806040

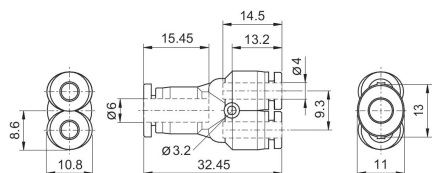

R412005081

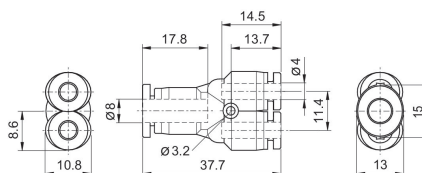

2121808060

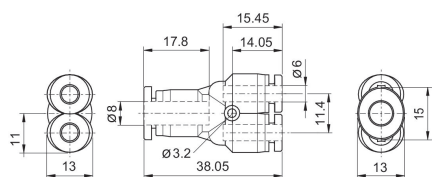

R412005082

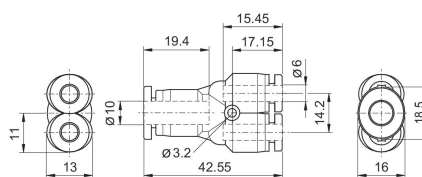

2121810080

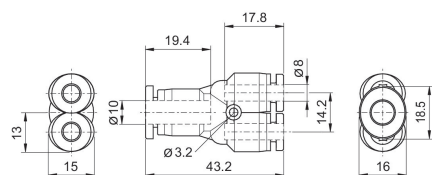

R412005083

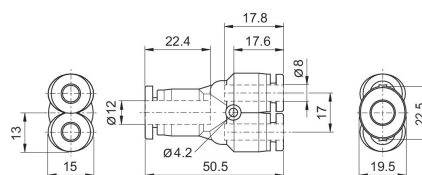

R412005080

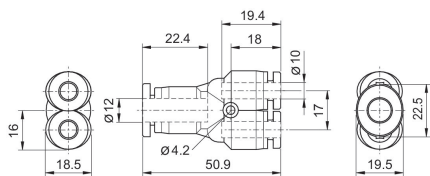

Serie QR1-S-RYD standard

Raccordo ad innesto ad Y, riduttore
doppio
Raccordo ad innesto
Raccordo ad innesto

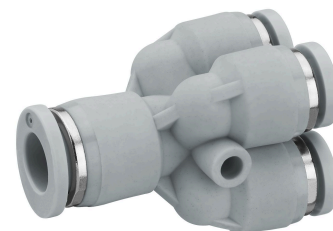

G	Ø D	Unità di fornitura [Pezzo]	Codice
Ø 6	Ø 4	10	R412005344
Ø 8	Ø 6	10	R412005345

R412005344

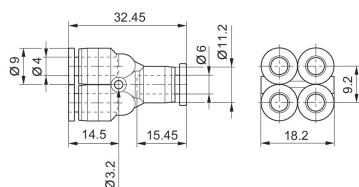

R412005345

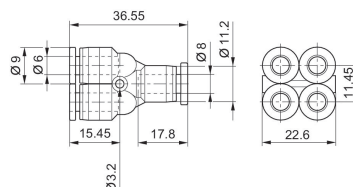

Serie QR1-S-RXS standard

Raccordo ad innesto ad X
Raccordo ad innesto
Raccordo ad innesto



G	Ø D	Unità di fornitura [Pezzo]	Codice
Ø 4	Ø 4	10	R412005361
Ø 6	Ø 6	10	R412005362
Ø 8	Ø 8	10	R412005363
Ø 10	Ø 10	10	R412005364

R412005361

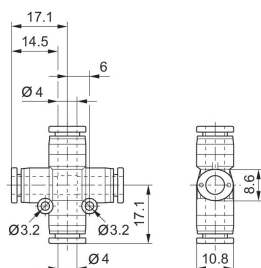

R412005362

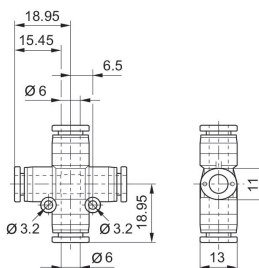

R412005363

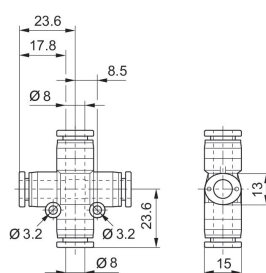

R412005364

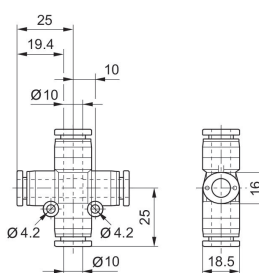

Serie QR1-S-RED standard

raccordo ad innesto diritto, riduttore
Raccordo ad innesto
bussola ad innesto

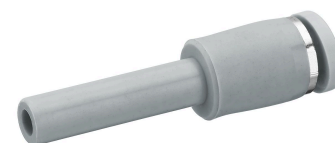

G	Ø D	Unità di fornitura [Pezzo]	Codice
Ø 4	Ø 6	10	2121706040
Ø 4	Ø 8	10	2121708040
Ø 4	Ø 10	10	2121710040
Ø 6	Ø 8	10	2121708060
Ø 6	Ø 10	10	2121710060
Ø 6	Ø 12	10	2121712060
Ø 8	Ø 10	10	2121710080
Ø 8	Ø 12	10	2121712080
Ø 8	Ø 14	10	2121714080
Ø 10	Ø 12	10	2121712100
Ø 10	Ø 14	10	2121714100
Ø 12	Ø 14	10	2121714120

2121706040

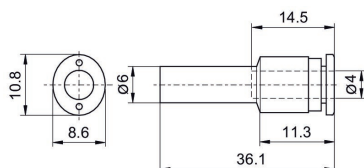

2121708040

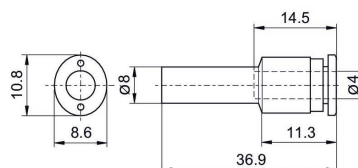

2121710040

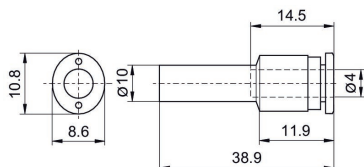

2121708060

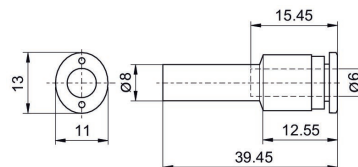

2121710060

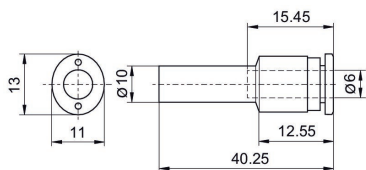

2121712060

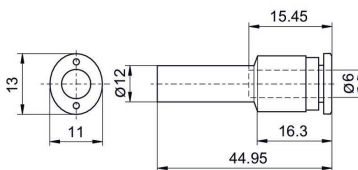

2121710080

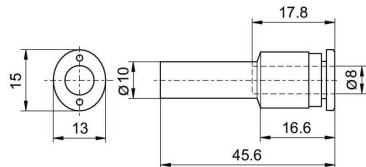

2121712080

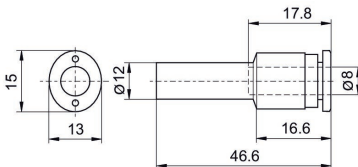

2121714080

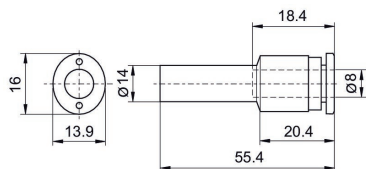

2121712100

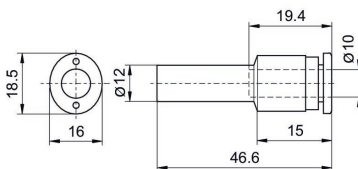

2121714100

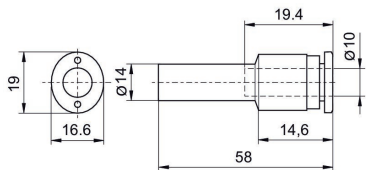

2121714120

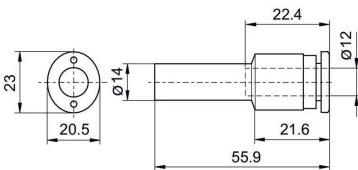

Serie QR1-S-RVA standard

Raccordo ad innesto a gomito
bussola ad innesto
Raccordo ad innesto



G	Ø D	Unità di fornitura [Pezzo]	Codice
Ø 4	Ø 4	10	2121304040
Ø 6	Ø 6	10	2121306060
Ø 8	Ø 8	10	2121308080
Ø 10	Ø 10	10	2121310100
Ø 12	Ø 12	10	R412005036

2121304040

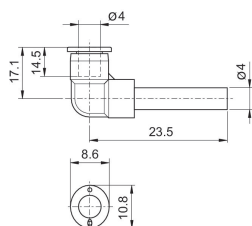

2121306060

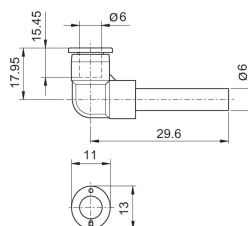

2121308080

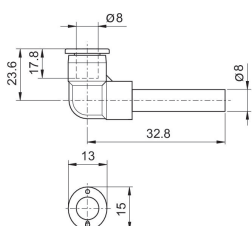

2121310100

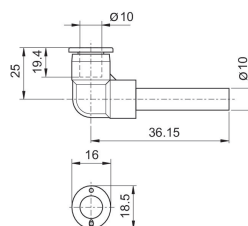

R412005036

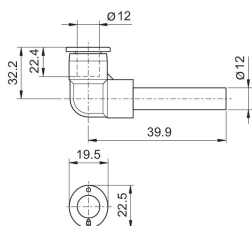

Serie QR1-S-RLL standard

Raccordo ad innesto a gomito
Bussola ad innesto lunga
Raccordo ad innesto



G	Ø D	Unità di fornitura [Pezzo]	Codice
Ø 4	Ø 4	10	R412005039
Ø 6	Ø 6	10	R412005040
Ø 8	Ø 8	10	R412005041
Ø 10	Ø 10	10	R412005042
Ø 12	Ø 12	10	R412005043

R412005039

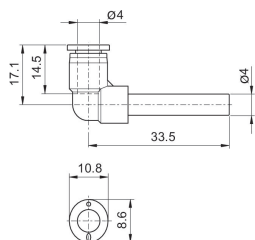

R412005040

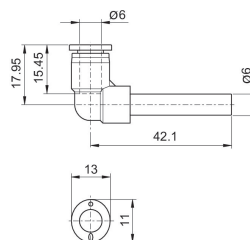

R412005041

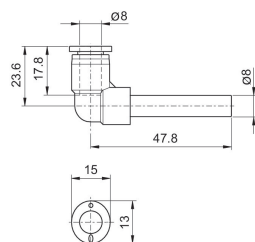

R412005042

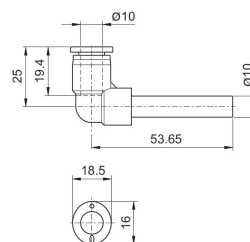

R412005043

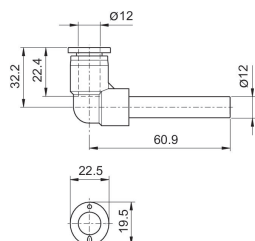

Serie QR1-S-RVR standard

Raccordo ad innesto a gomito
Attacco ad innesto riduttore
bussola ad innesto



G	Ø D	Unità di fornitura [Pezzo]	Codice
Ø 4	Ø 6	10	2121304060
Ø 6	Ø 8	10	2121306080
Ø 8	Ø 10	10	R412005034

2121304060

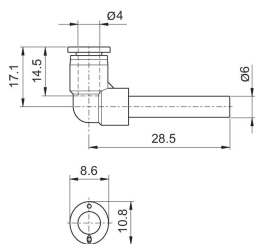

2121306080

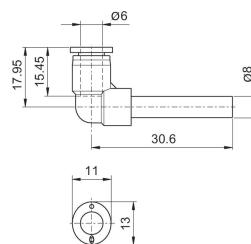

R412005034

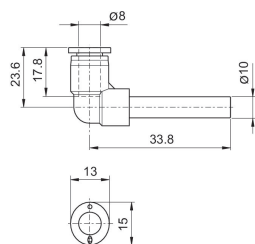

Serie QR1-S-RTC standard

Attacco ad innesto a T
bussola ad innesto
Raccordo ad innesto

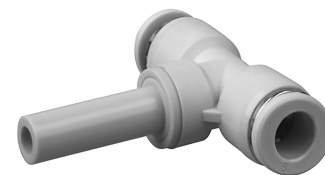

G	Ø D	Unità di fornitura [Pezzo]	Codice
Ø 6	Ø 6	10	2122706000
Ø 8	Ø 8	10	2122708000
Ø 12	Ø 12	10	R412010596

2122706000

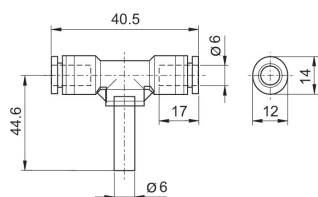

2122708000

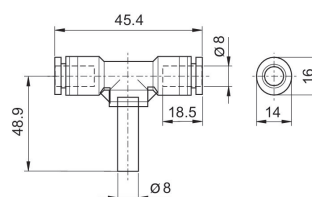

R412010596

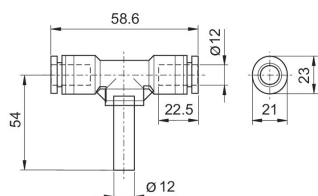

Serie QR1-S-RY2 standard

Attacco ad innesto ad Y
bussola ad innesto
Raccordo ad innesto



G	Ø D	Unità di fornitura [Pezzo]	Codice
Ø 4	Ø 4	10	R412005332
Ø 6	Ø 6	10	R412005333
Ø 8	Ø 8	10	R412005334
Ø 10	Ø 10	10	R412005335
Ø 12	Ø 12	10	R412005336

R412005332

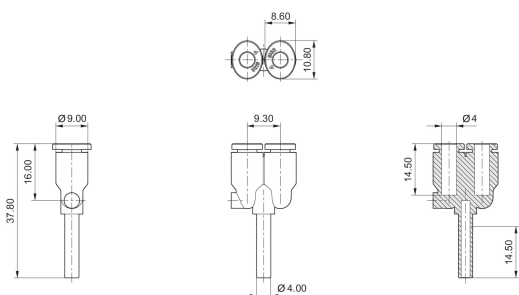

R412005333

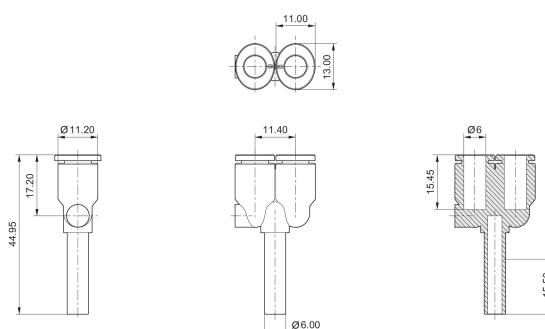

R412005334

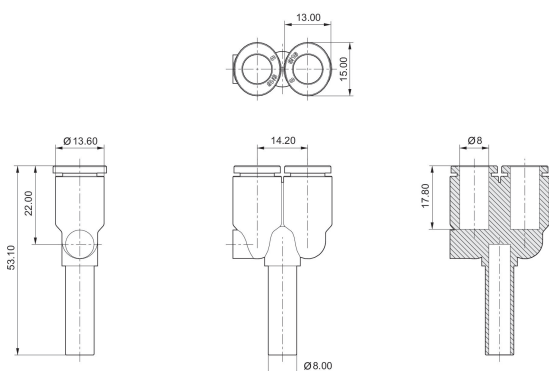

R412005335

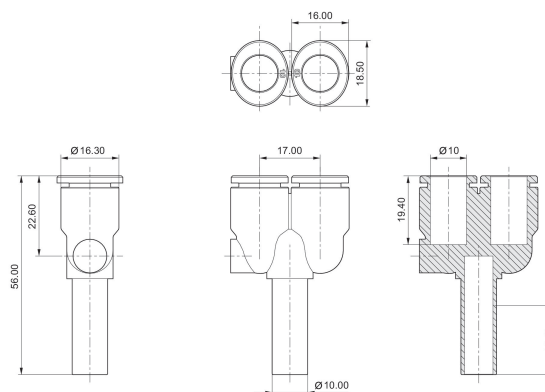

R412005336

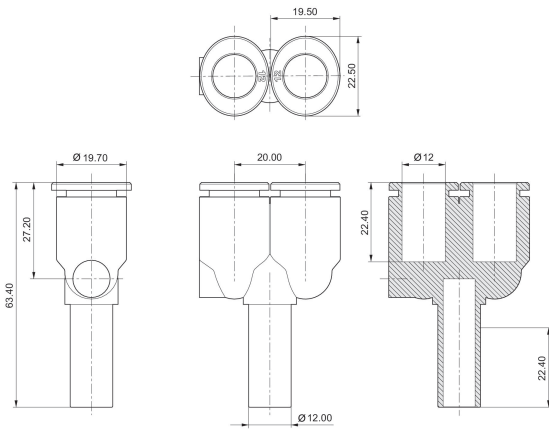

Serie QR1-S-R2R standard

Attacco ad innesto ad Y, riduttore
Raccordo ad innesto
bussola ad innesto

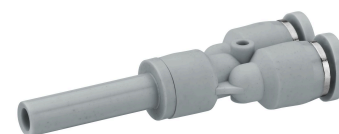

G	Ø D	Unità di fornitura [Pezzo]	Codice
Ø 4	Ø 6	10	R412005337
Ø 6	Ø 8	10	R412005338
Ø 8	Ø 10	10	R412005339
Ø 10	Ø 12	10	R412005340

R412005337

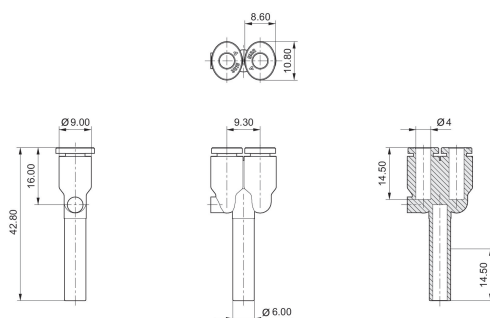

R412005338

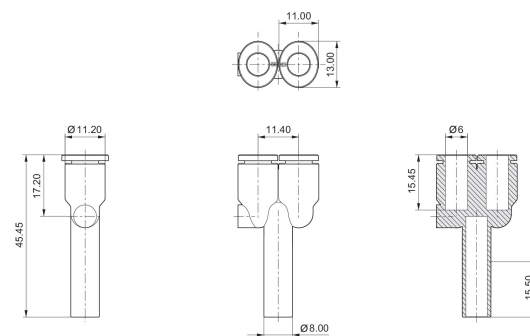

R412005339

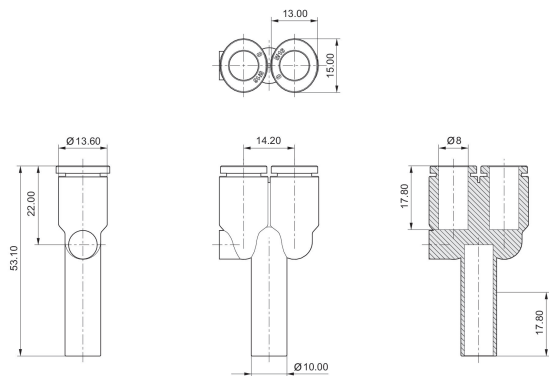

R412005340

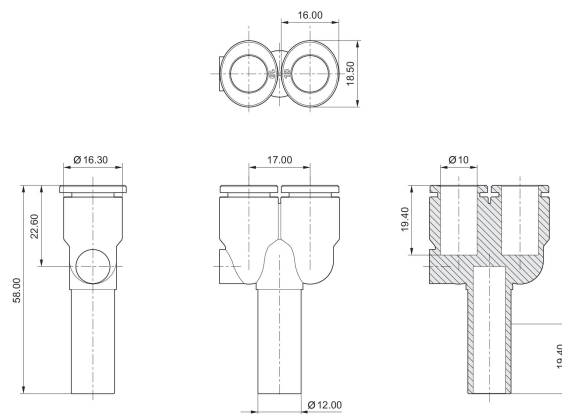

Serie QR1-S-RY4 standard

Attacco ad innesto ad Y, riduttore
bussola ad innesto
Raccordo ad innesto

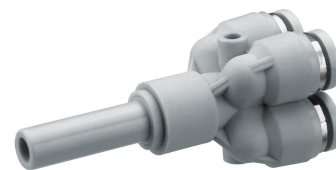

G	Ø D	Unità di fornitura [Pezzo]	Codice
Ø 4	Ø 6	10	R412005341
Ø 4	Ø 8	10	R412005342

R412005341

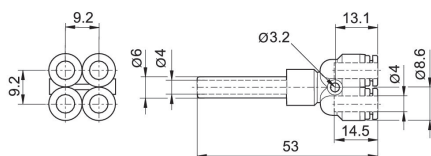

R412005342

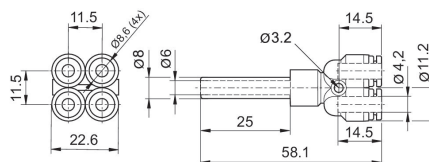

Serie QR1-S-RCA standard

Tappo di otturazione
Raccordo ad innesto



G	Unità di fornitura [Pezzo]	Codice
Ø 4	20	R412005111
Ø 6	20	R412005112
Ø 8	20	R412005113
Ø 10	20	R412005114
Ø 12	20	R412005115

R412005111

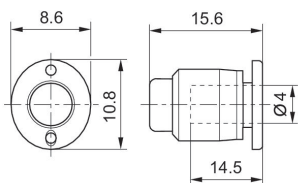

R412005112

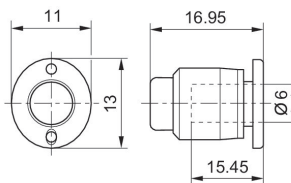

R412005113

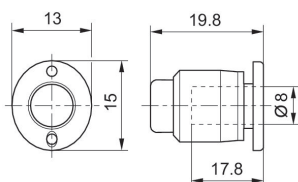

R412005114

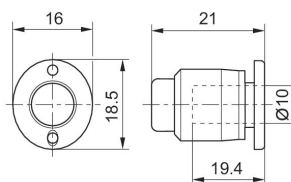

R412005115

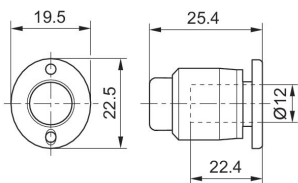

Serie QR1-S-RBS standard

Connettore di chiusura
bussola ad innesto

G	Unità di fornitura [Pezzo]	Codice
Ø 4	20	2123204000
Ø 6	20	2123206000
Ø 8	20	2123208000
Ø 10	20	2123210000
Ø 12	20	2123212000
Ø 14	10	2123214000
Ø16	10	R412005331

Dimensioni

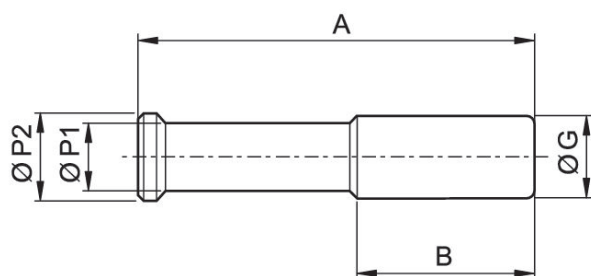

Codice	Raccordo G	A	B	Ø P1	Ø P2
2123204000		28	16	3	4
2123206000		32	17	4	6
2123208000		39	21,5	5	9
2123210000		42	21	8	10
2123212000		44	30	8	12
2123214000		45	24.6	8	14
R412005331		46	24.8	10	16

Serie QR1-S-RDS standard

Inserto
bussola ad innesto
bussola ad innesto



G	Ø D	Unità di fornitura [Pezzo]	Codice
Ø 4	Ø 4	10	2123104000
Ø 6	Ø 6	10	2123106000
Ø 8	Ø 8	10	2123108000
Ø 10	Ø 10	10	2123110000
Ø 12	Ø 12	10	2123112000

Dimensioni

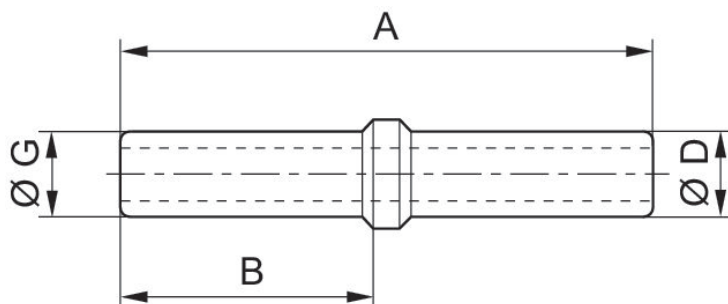

Codice	Raccordo D	Raccordo G	A	B
2123104000			37,5	17,8
2123106000			39,7	18,7
2123108000			43,4	20,7
2123110000			47,2	22,6
2123112000			53	25,5
2123114000			53	-
R412005322			54	24,8

Serie QR1-S-RDR standard

Inserti, riduttore
bussola ad innesto
bussola ad innesto



G	Ø D	Unità di fornitura [Pezzo]	Codice
Ø 6	Ø 4	10	R412005323
Ø 8	Ø 4	10	R412005324
Ø 8	Ø 6	10	R412005325
Ø 10	Ø 6	10	R412005326
Ø 10	Ø 8	10	R412005327
Ø 12	Ø 8	10	R412005328
Ø 12	Ø 10	10	R412005329

R412005323

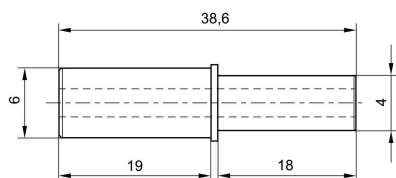

R412005324

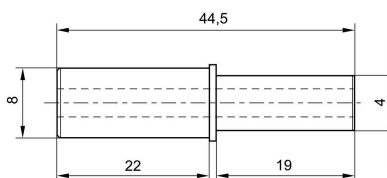

R412005325

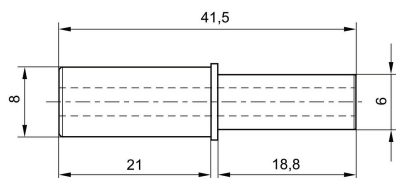

R412005326

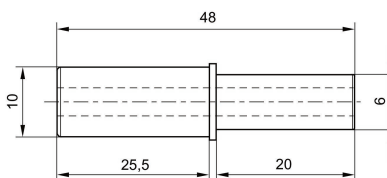

R412005327

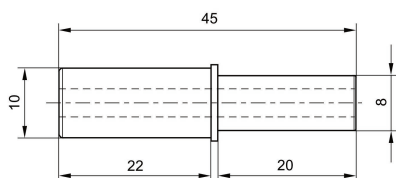

R412005328

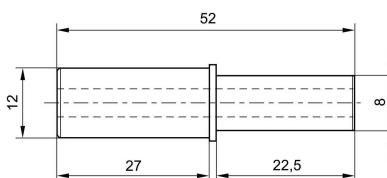

R412005329

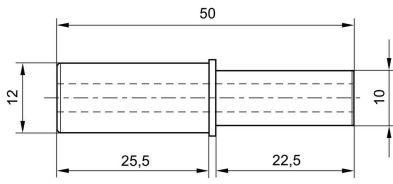

Serie QR1-S-M2R Mini

Attacco ad innesto ad Y, riduttore
bussola ad innesto
Raccordo ad innesto

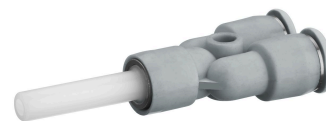

G	Ø D	Unità di fornitura [Pezzo]	Codice
Ø 4	Ø 3	25	R412005445
Ø 6	Ø 4	25	R412005446

Dimensioni

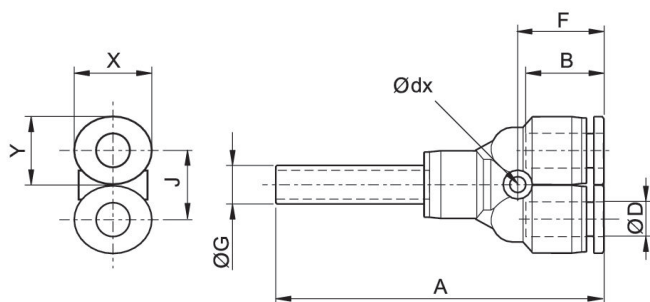

Codice	Raccordo D	Raccordo G	Ø dx	A	B	F	J	X	Y
R412005445	Ø 3	Ø 4	3.2	33	9.5	13.4	8	7	6
R412005446	Ø 4	Ø 6	3.2	38.5	11.5	13.6	10.5	10	8

Serie QR1-S-MAN Mini

raccordo diritto con testa esagonale
filettatura esterna
Raccordo ad innesto



G	Ø D	Unità di fornitura [Pezzo]	Codice
M3	Ø 3	25	R412005116
M3	Ø 4	25	R412005117
M5	Ø 3	25	R412005118
M5	Ø 4	25	R412005119
M5	Ø 6	25	R412005120
M6	Ø 3	25	R412005121
M6	Ø 4	25	R412005122
M6	Ø 6	25	R412005123
G 1/8	Ø 4	25	R412005124
G 1/8	Ø 6	25	R412005125

Dimensioni

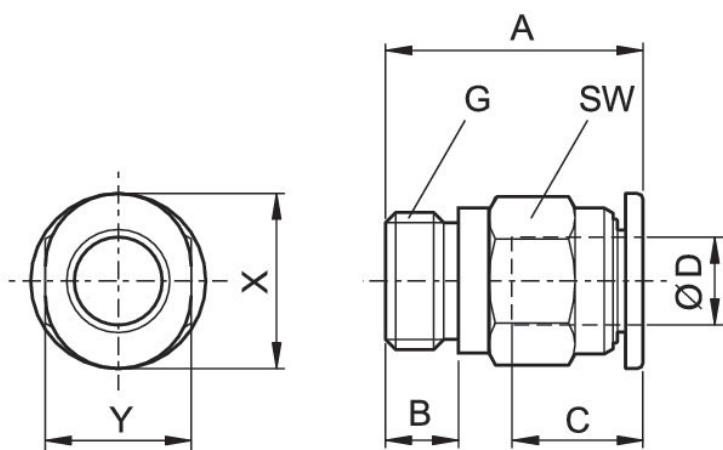

Codice	Raccordo D	Raccordo G	A	B	C	SW	X	Y
R412005116	Ø 3	M3	13.6	3	9.5	6	7	6
R412005117	Ø 4	M3	17.2	3	11.5	8	10	8
R412005118	Ø 3	M5	16.2	4	9.5	8	7	6
R412005119	Ø 4	M5	16.2	4	11.5	8	10	8

Codice	Raccordo D	Raccordo G	A	B	C	SW	X	Y
R412005120	Ø 6	M5	17.3	4 M3	12.5	10	12	10
R412005121	Ø 3	M6	17	5	9.5	8	7	6
R412005122	Ø 4	M6	17.4	5	11.5	8	10	8
R412005123	Ø 6	M6	18.3	5	12.5	10	12	10
R412005124	Ø 4	G 1/8	12.7	5	11.5	10	10	8
R412005125	Ø 6	G 1/8	14.9	5	12.5	10	12	10

Serie QR1-S-MBS Mini

Connettore di chiusura
bussola ad innesto

G	Unità di fornitura [Pezzo]	Codice
Ø 3	25	R412005447

Dimensioni

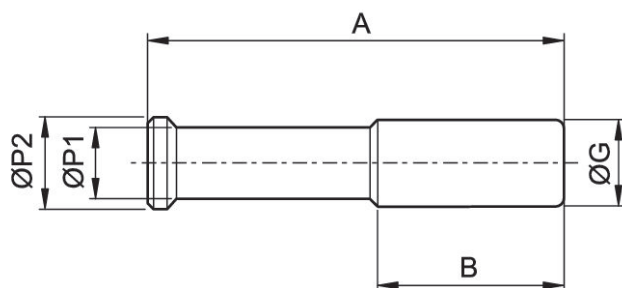

Codice	Raccordo G	A	B	Ø P1	Ø P2
R412005447	Ø 3	22	9.5	3	4

Serie QR1-S-MED Mini

raccordo ad innesto diritto, riduttore
bussola ad innesto
Raccordo ad innesto



G	Ø D	Unità di fornitura [Pezzo]	Codice
Ø 4	Ø 3	25	R412005437
Ø 6	Ø 4	25	R412005438

Dimensioni

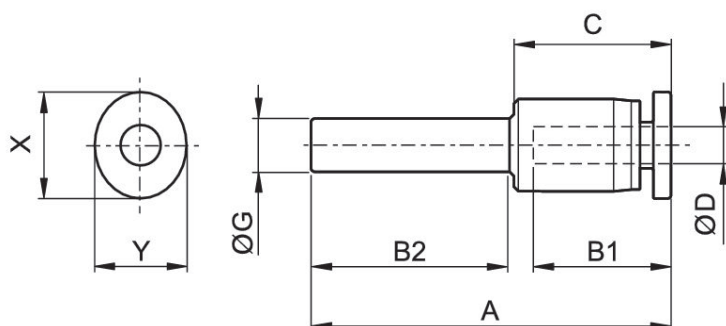

Codice	Raccordo D	Raccordo G	A	B1	B2	C	X	Y
R412005437	Ø 3	Ø 4	29.2	9.5	11.5	11.2	7	6
R412005438	Ø 4	Ø 6	33.2	11.5	12.5	13.2	10	8

Serie QR1-S-MIN Mini

raccordo diritto con esagono incassato
filettatura esterna
Raccordo ad innesto



G	Ø D	Unità di fornitura [Pezzo]	Codice
M3	Ø 3	25	R412005264
M3	Ø 4	25	R412005265
M5	Ø 3	25	R412005266
M5	Ø 4	25	R412005267
M5	Ø 6	25	R412005268
M6	Ø 3	25	R412005269
M6	Ø 4	25	R412005270
M6	Ø 6	25	R412005271
M7	Ø 4	25	R412005272
M7	Ø 6	25	R412005273
G 1/8	Ø 4	25	R412005274
G 1/8	Ø 6	25	R412005275

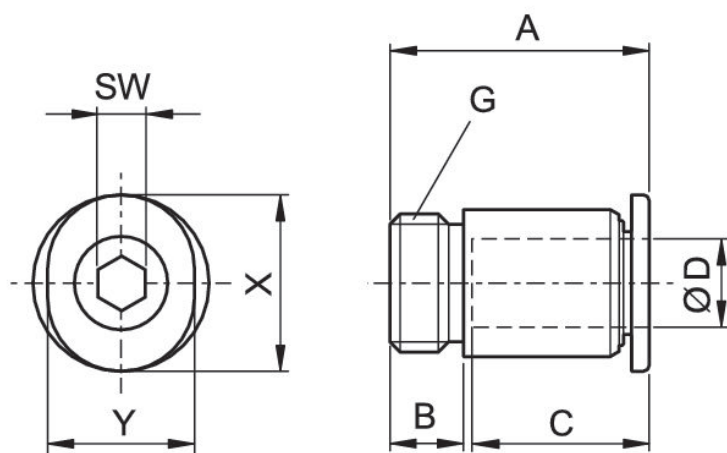

Codice	Raccordo D	Raccordo G	A	B	C	SW	X	Y
R412005264	Ø 3	M3	15.9	3	9.5	1.5	7	6
R412005265	Ø 4	M3	18	3	11.5	1.5	10	8
R412005266	Ø 3	M5	18	4	9.5	2	7	6

Codice	Raccordo D	Raccordo G	A	B	C	SW	X	Y
R412005267	Ø 4	M5	16.3	4	11.5	2.5	10	8
R412005268	Ø 6	M5	17.8	4	12.5	2.5	12	10
R412005269	Ø 3	M6	20.2	5	9.5	3	7	6
R412005270	Ø 4	M6	20.2	5	11.5	3	10	8
R412005271	Ø 6	M6	18.8	5	12.5	3	12	10
R412005272	Ø 4	M7	21.4	5	11.5	3	10	8
R412005273	Ø 6	M7	20.1	5	12.5	3	12	10
R412005274	Ø 4	G 1/8	17	5	11.5	3	10	8
R412005275	Ø 6	G 1/8	20.6	5	12.5	4	12	10

Serie QR1-S-MLT Mini

Raccordo a gomito
filettatura esterna
Raccordo ad innesto

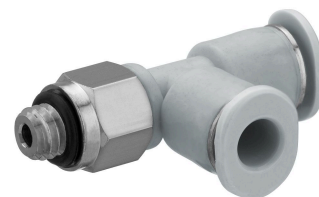

G	Ø D	Unità di fornitura [Pezzo]	Codice
M5	Ø 4	25	R412005405
M5	Ø 6	25	R412005406
G 1/8	Ø 4	25	R412005410
G 1/8	Ø 6	25	R412005411

Dimensioni

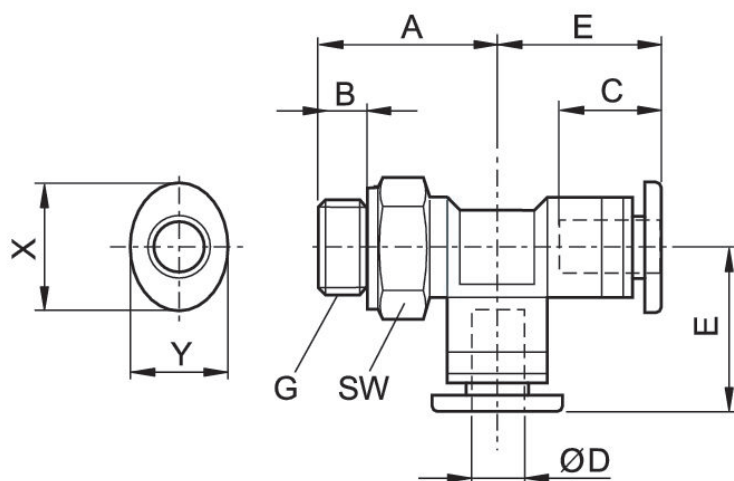

Codice	Raccordo D	Raccordo G	A	B	C	E	SW	X	Y
R412005405	Ø 4	M5	15	4	11.5	13.1	8	10	8
R412005406	Ø 6	M5	17	4	12.5	14.4	8	12	10
R412005410	Ø 4	G 1/8	13.4	5	11.5	13.1	10	10	8
R412005411	Ø 6	G 1/8	15	5	12.5	14.4	10	12	10

Serie QR1-S-MSK Mini

Raccordo ad innesto diretto
Raccordo ad innesto
Raccordo ad innesto



G	Ø D	Unità di fornitura [Pezzo]	Codice
Ø 3	Ø 3	25	R412005412
Ø 4	Ø 4	25	R412005413
Ø 6	Ø 6	25	R412005414

Dimensioni

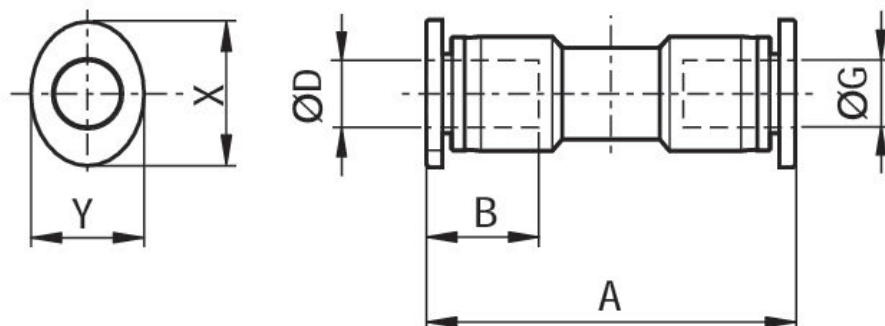

Codice	Raccordo D	Raccordo G	A	B	X	Y
R412005412	Ø 3	Ø 3	20.4	9.5	7	6
R412005413	Ø 4	Ø 4	23.8	11.5	10	8
R412005414	Ø 6	Ø 6	25.1	12.5	12	10

Serie QR1-S-MSM Mini

Raccordo passaparete, metallo
Raccordo ad innesto
Raccordo ad innesto



G	Ø D	Unità di fornitura [Pezzo]	Codice
Ø 4	Ø 4	25	R412005418
Ø 6	Ø 6	25	R412005419

Dimensioni

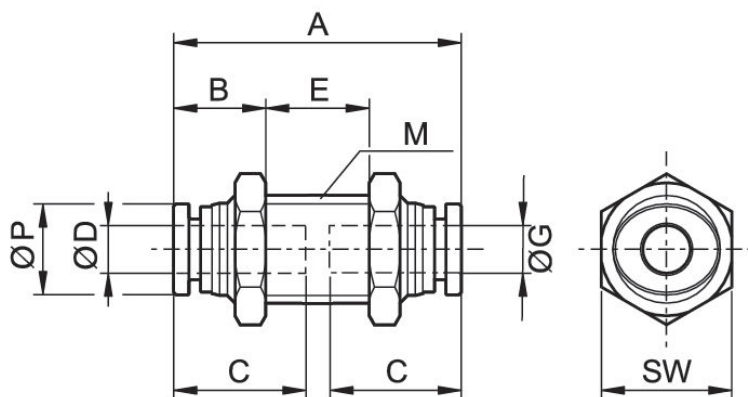

Codice	Raccordo D	Raccordo G	M	A	B	C	E	SW	Ø P
R412005418	Ø 4	Ø 4	M10x1,0	24	9	11.5	7.5	12	8
R412005419	Ø 6	Ø 6	M12x1,0	25.9	10.5	12.5	6	14	10.5

Serie QR1-S-MSR Mini

Raccordo ad innesto diritto, riduzione

Raccordo ad innesto

Raccordo ad innesto



G	Ø D	Unità di fornitura [Pezzo]	Codice
Ø 4	Ø 3	25	R412005415
Ø 6	Ø 4	25	R412005416

Dimensioni

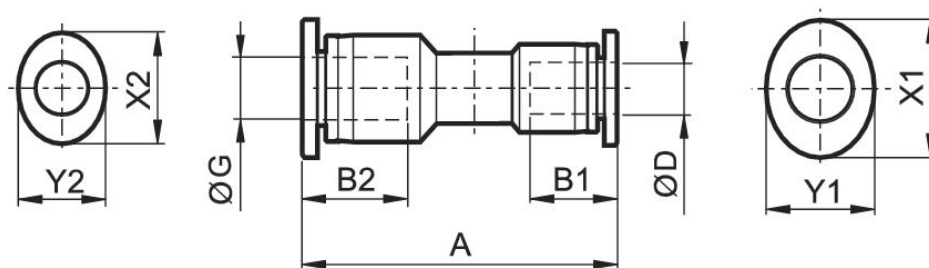

Codice	Raccordo D	Raccordo G	A	B1	B2	X1	X2	Y1	Y2
R412005415	Ø 3	Ø 4	22.5	9.5	11.5	7	10	6	8
R412005416	Ø 4	Ø 6	24	11.5	12.5	10	12	8	10

Serie QR1-S-MTK Mini

Raccordo ad innesto a T
Raccordo ad innesto
Raccordo ad innesto



G	Ø D	Unità di fornitura [Pezzo]	Codice
Ø 3	Ø 3	25	R412005426
Ø 4	Ø 4	25	R412005427
Ø 6	Ø 6	25	R412005428

Dimensioni

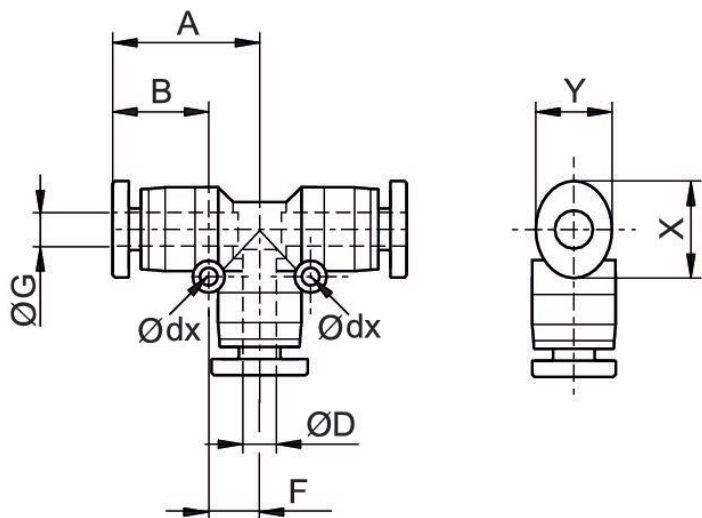

Codice	Raccordo D	Raccordo G	Ø dx	A	B	F	X	Y
R412005426	Ø 3	Ø 3	3.2	11.4	9.5	4.5	7	6
R412005427	Ø 4	Ø 4	3.2	13.9	11.5	5.8	10	8
R412005428	Ø 6	Ø 6	3.2	15.4	12.5	6.5	12	10

Serie QR1-S-MTT Mini

Raccordo a vite a T
filettatura esterna
Raccordo ad innesto

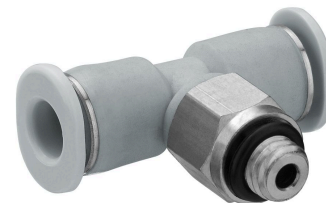

G	Ø D	Unità di fornitura [Pezzo]	Codice
M5	Ø 4	25	R412005395
M5	Ø 6	25	R412005396
G 1/8	Ø 4	25	R412005400
G 1/8	Ø 6	25	R412005401

Dimensioni

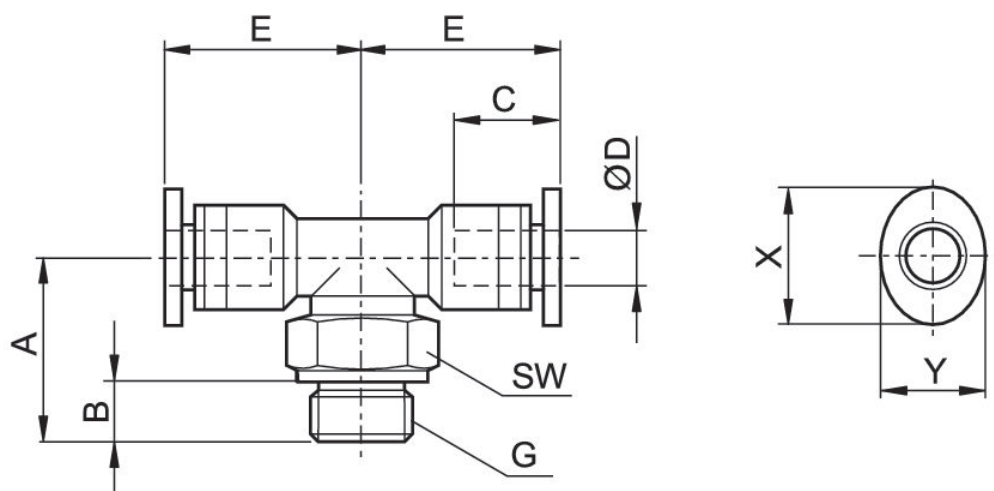

Codice	Raccordo D	Raccordo G	A	B	C	E	SW	X	Y
R412005395	Ø 4 M5 M5	M5	15	4	11.5	13.1	8	10	8
R412005396	Ø 6	M5	16	4	12.5	14.4	8	12	10
R412005400	Ø 4	G 1/8	13.4	5	11.5	13.1	12	10	8
R412005401	Ø 6	G 1/8	14.4	5	12.5	14.4	10	12	10

Serie QR1-S-MVA Mini

Raccordo ad innesto a gomito
bussola ad innesto
Raccordo ad innesto



G	Ø D	Unità di fornitura [Pezzo]	Codice
Ø 3	Ø 3	25	R412005439
Ø 4	Ø 4	25	R412005440
Ø 6	Ø 6	25	R412005441

Dimensioni

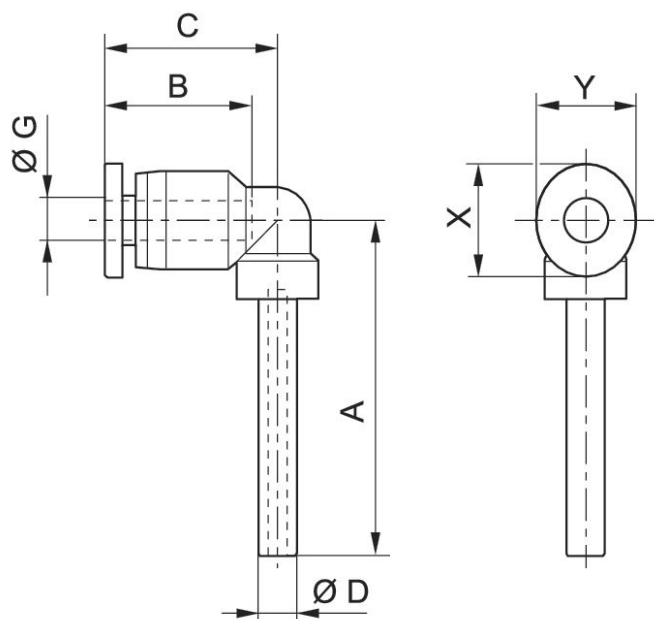

Codice	Raccordo D	Raccordo G	A	B	C	X	Y
R412005439	Ø 3	Ø 3	21.6	9.5	11.2	7	6
R412005440	Ø 4	Ø 4	27.6	11.5	15.6	10	8
R412005441	Ø 6	Ø 6	29.6	12.5	16.9	12	10

Serie QR1-S-MVK Mini

Raccordo ad innesto a gomito

Raccordo ad innesto

Raccordo ad innesto



G	Ø D	Unità di fornitura [Pezzo]	Codice
Ø 3	Ø 3	25	R412005423
Ø 4	Ø 4	25	R412005424
Ø 6	Ø 6	25	R412005425

Dimensioni

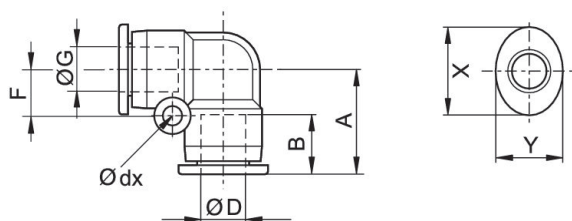

Codice	Raccordo D	Raccordo G	Ø dx	A	B	F	X	Y
R412005423	Ø 3	Ø 3	3.2	11.4	9.5	4.5	7	6
R412005424	Ø 4	Ø 4	3.2	13.9	11.5	5.8	10	8
R412005425	Ø 6	Ø 6	3.2	15.4	12.5	6.5	12	10

Serie QR1-S-MVL Mini

raccordo a gomito lungo
filettatura esterna
Raccordo ad innesto



G	Ø D	Unità di fornitura [Pezzo]	Codice
M3	Ø 3	25	R412005381
M3	Ø 4	25	R412005382
M5	Ø 4	25	R412005384
M5	Ø 6	25	R412005385
G 1/8	Ø 4	25	R412005390
G 1/8	Ø 6	25	R412005391

Dimensioni

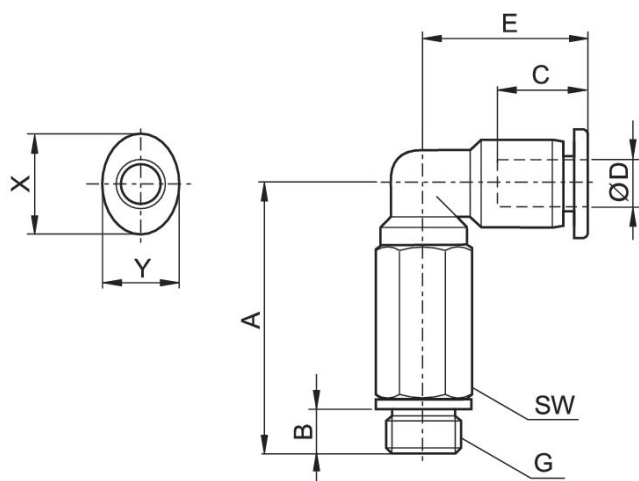

Codice	Raccordo D	Raccordo G	A	B	C	E	SW	X	Y
R412005381	Ø 3	M3	19.4	3	9.5	11.2	6	7	6
R412005382	Ø 4	M3	23	3	11.5	15.6	8	10	8
R412005384	Ø 4	M5	26	4	11.5	15.6	8	10	8
R412005385	Ø 6	M5	26	4	12.5	16.9	8	12	10
R412005390	Ø 4	G 1/8	25.1	5	11.5	15.6	10	10	8
R412005391	Ø 6	G 1/8	26.4	5	12.5	16.9	10	12	10

Serie QR1-S-MVS Mini

Raccordo passaparete ad innesto a gomito

Raccordo ad innesto

Raccordo ad innesto



G	Ø D	Unità di fornitura [Pezzo]	Codice
Ø 4	Ø 4	25	R412005421
Ø 6	Ø 6	25	R412005422

Dimensioni

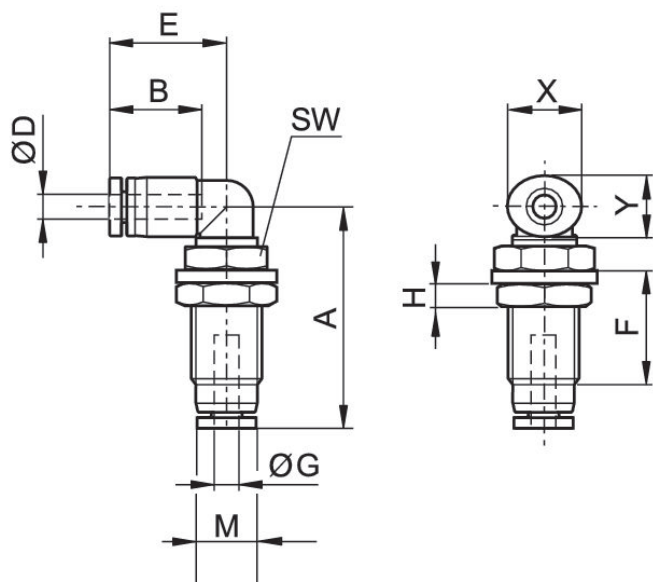

Codice	Raccordo D	Raccordo G	M	A	B	E	F	H	SW	X
R412005421	Ø 4	Ø 4	M10x1,0	24.4	11.5	15.3	13	3	12	10
R412005422	Ø 6	Ø 6	M12x1,0	31.5	12.5	16.3	16.6	4	14	12

Codice	Y
R412005421	8
R412005422	10

Serie QR1-S-MVT Mini

raccordo a gomito
filettatura esterna
Raccordo ad innesto

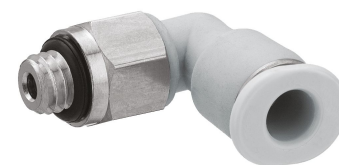

G	Ø D	Unità di fornitura [Pezzo]	Codice
M3	Ø 3	25	R412005284
M3	Ø 4	25	R412005285
M5	Ø 3	25	R412005286
M5	Ø 4	25	R412005287
M5	Ø 6	25	R412005288
M6	Ø 3	25	R412005289
M6	Ø 6	25	R412005627
M6	Ø 4	25	R412005628
M7	Ø 4	25	R412005377
M7	Ø 6	25	R412005378
G 1/8	Ø 4	25	R412005379
G 1/8	Ø 6	25	R412005380

Dimensioni

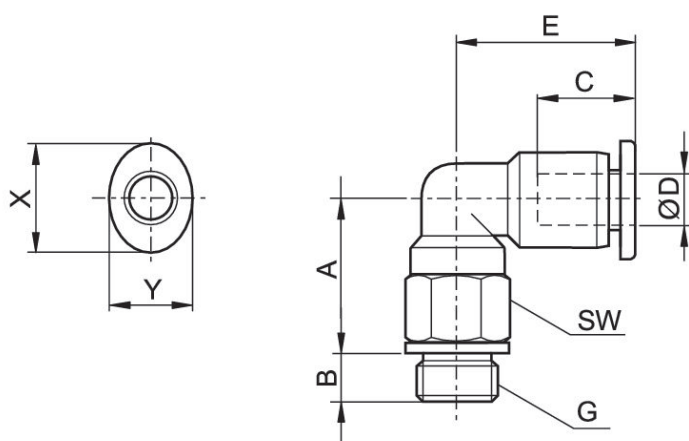

Codice	Raccordo D	Raccordo G	A	B	C	E	SW	X	Y
R412005284	Ø 3	M3	10.4	3	9.5	11.2	6	7	6
R412005285	Ø 4	M3	12	3	11.5	15.6	8	10	8
R412005286	Ø 3	M5	11.3	3.5	9.5	11.2	8	7	6

Codice	Raccordo D	Raccordo G	A	B	C	E	SW	X	Y
R412005287	Ø 4	M5	11.6	3.5	11.5	15.6	8	10	8
R412005288	Ø 6	M5	12.9	3.5	12.5	16.9	8	12	10
R412005289	Ø 3	M6	11.9	4.5	9.5	11.2	8	7	6
R412005628	Ø 4	M6	11.6	4.5	12.5	15.6	8	12	10
R412005627	Ø 6	M6	12.9	4.5	11.5	16.9	10	10	8
R412005377	Ø 4	M7	13.7	5.5	11.5	15.6	8	10	8
R412005378	Ø 6	M7	15	5.5	12.5	16.9	8	12	10
R412005379	Ø 4	G 1/8	12.6	5	11.5	15.6	12	10	8
R412005380	Ø 6	G 1/8	17	5	12.5	16.9	10	12	10

Serie QR1-S-MXS Mini

Raccordo ad innesto ad X
 Raccordo ad innesto
 Raccordo ad innesto



G	Ø D	Unità di fornitura [Pezzo]	Codice
Ø 4	Ø 4	25	R412005435
Ø 6	Ø 6	25	R412005436

Dimensioni

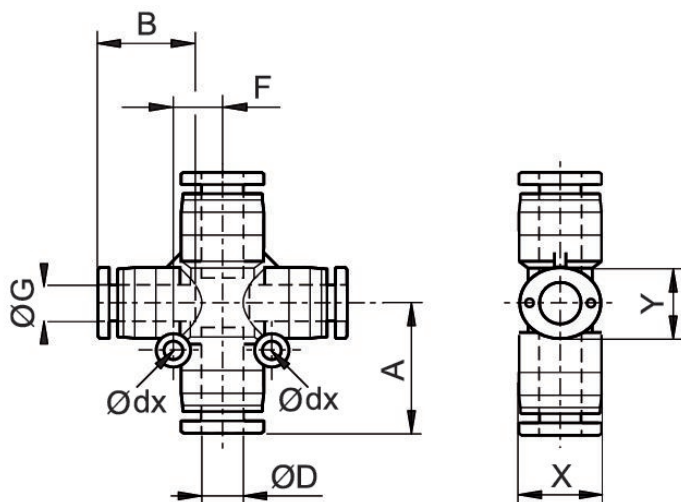

Codice	Raccordo D	Raccordo G	Ø dx	A	B	F	X	Y
R412005435	Ø 4	Ø 4	3.2	13.6	11.5	5.5	10	8
R412005436	Ø 6	Ø 6	3.2	15.9	12.5	6.5	12	10

Serie QR1-S-MYK Mini

Raccordo ad innesto ad Y

Raccordo ad innesto

Raccordo ad innesto

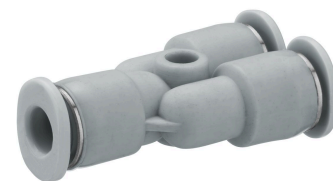

G	Ø D	Unità di fornitura [Pezzo]	Codice
Ø 3	Ø 3	25	R412005429
Ø 4	Ø 4	25	R412005430
Ø 6	Ø 6	25	R412005431

Dimensioni

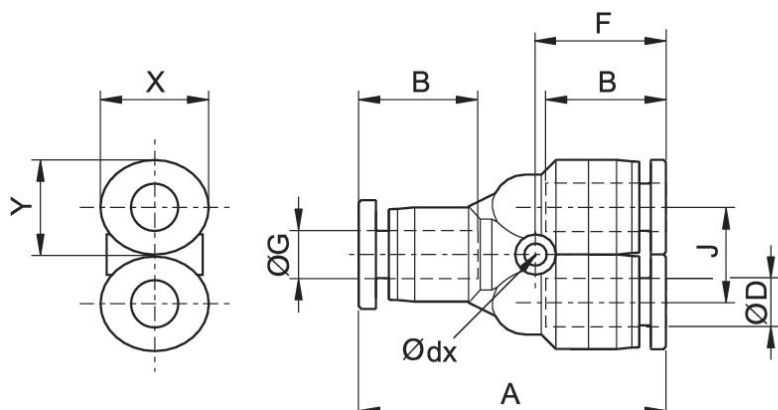

Codice	Raccordo D	Raccordo G	Ø dx	A	B	F	J	X	Y
R412005429	Ø 3	Ø 3	3.2	29.9	9.5	13.2	8	7	6
R412005430	Ø 4	Ø 4	3.2	30.1	11.5	13.3	8	10	8
R412005431	Ø 6	Ø 6	3.2	32.1	12.5	13.6	10.5	12	10

Serie QR1-S-MYR Mini

Raccordo ad innesto ad Y, riduttore
Raccordo ad innesto
Raccordo ad innesto

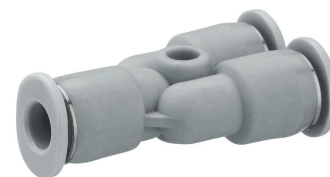

G	Ø D	Unità di fornitura [Pezzo]	Codice
Ø 4	Ø 3	25	R412005432
Ø 6	Ø 4	25	R412005433

Dimensioni

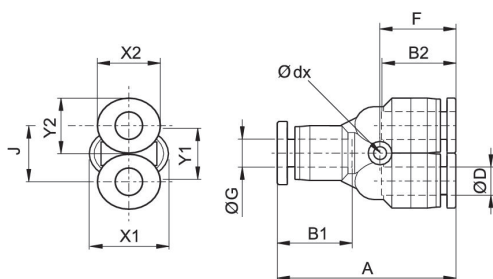

Codice	Raccordo D	Raccordo G	Ø dx	A	B1	B2	F	J	X1	X2
R412005432	Ø 3	Ø 4	3.2	30	11.5	9.5	13.4	8	10	7
R412005433	Ø 4	Ø 6	3.2	31.5	12.5	11.5	13.6	10.5	12	10

Codice	Y1	Y2
R412005432	8	6
R412005433	10	8

Serie QR1-S-MYZ Mini

Attacco ad innesto ad Y
bussola ad innesto
Raccordo ad innesto



G	Ø D	Unità di fornitura [Pezzo]	Codice
Ø 4	Ø 4	25	R412005443
Ø 6	Ø 6	25	R412005444

Dimensioni

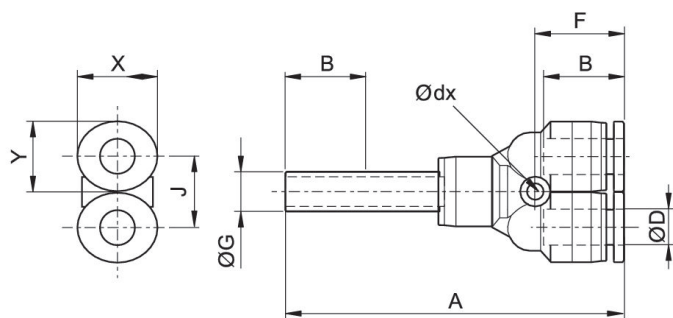

Codice	Raccordo D	Raccordo G	Ø dx	A	B	F	J	X	Y
R412005443	Ø 4	Ø 4	3.2	45	11.5	13.3	8	10	8
R412005444	Ø 6	Ø 6	3.2	50.5	12.5	13.6	10.4	12	10

Efficient pneumatic solutions, our program: cylinders and drives, valves and valve systems, air supply management



Visit us: [Emerson.com/Aventics](https://www.emerson.com/aventics)

Your local contact: [Emerson.com/contactus](https://www.emerson.com/contactus)



[Emerson.com](https://www.emerson.com)



[Facebook.com/EmersonAutomationSolutions](https://www.facebook.com/EmersonAutomationSolutions)



[LinkedIn.com/company/Emerson-Automation-Solutions](https://www.linkedin.com/company/Emerson-Automation-Solutions)



[Twitter.com/EMR_Automation](https://twitter.com/EMR_Automation)

An example configuration is depicted on the title page. The delivered product may thus vary from that in the illustration. Subject to change. This Document, as well as the data, specifications and other information set forth in it, are the exclusive property of AVENTICS GmbH. It may not be reproduced or given to third parties without its consent. Only use the AVENTICS products shown in industrial applications. Read the product documentation completely and carefully before using the product. Observe the applicable regulations and laws of the respective country. When integrating the product into applications, note the system manufacturer's specifications for safe use of the product. The data specified only serve to describe the product. No statements concerning a certain condition or suitability for a certain application can be derived from our information. The information given does not release the user from the obligation of own judgment and verification. It must be remembered that the products are subject to a natural process of wear and aging.

The Emerson logo is a trademark and service mark of Emerson Electric Co. Brand logotype are registered trademarks of one of the Emerson family of companies. All other marks are the property of their respective owners. © 2019 Emerson Electric Co. All rights reserved.



CONSIDER IT SOLVED™